



TX677

2 watt UHF CB Handheld Radio

INSTRUCTION MANUAL



Preface

Copyright Notice

Standard Communications Pty Ltd reserves all rights to this document and the information contained herein. Reproduction, use or disclosure to third parties without express permission is strictly prohibited.

© 2018 Standard Communications Pty Ltd, Sydney, Australia

Safety Information

The TX677 is a radio transmitting device.

- When transmitting, keep the antenna more than 25 mm from any part of the head or body.
- Do not transmit near electrical blasting equipment or in explosive atmospheres.
- Do not allow children to operate a radio transmitter unsupervised.

Important Information Concerning UHF CB Radio

The use of the Citizen Band radio service is licensed in Australia by the ACMA Radio communications (Citizens Band radio Stations) Class Licence and in New Zealand by the Ministry of Economic Development New Zealand (MED). A General User Radio Licence for Citizens Band radio and operation is subject to conditions contained in those licences. The class licence for users and equipment operating in the CB/PRS 477 MHz band has been amended. This radio meets the new 80 channel standard.

In simple terms the same amount of spectrum is available; however, radio transceivers can now operate in a narrower bandwidth and hence use less spectrum. These radios are generally referred to as narrowband or 12.5 kHz radios. By using 12.5 kHz channel spacing instead of 25 kHz, the 40 channels originally allocated can now be expanded to 80 channels thereby doubling the channel capacity and relieving congestion in the UHF CB/PRS band.

Original 40 channel wideband radios will continue to operate on the original 40 channels, however they will not be able to converse on the newer channels 41 – 80. The newer narrowband radios will be able to converse with all older 40 channel wideband radios on all channels 1 – 40 as well as the newer channels allocated from 41 – 80. The mixing of narrowband and wideband radios in the same spectrum can cause some possible operating issues of interference and varying levels of received volume.

Possible Issues

When a new narrowband radio receives a transmission from an older wideband radio the speech may sound loud and distorted – simply adjust your radio volume for best performance. When an older wideband radio receives a signal from a new narrowband radio, the speech may sound quiet – simply adjust your radio volume for best performance.

Depending on how close your receiving radio is to another transmitting radio, there can be interference from the transmitting radio if it is using a channel adjacent to the channel you are listening to. Simply try going up or down a few channels from the currently selected channel.

The above situations are not a fault of the radio but a symptom of operating wideband and narrowband radios in the same bandwidth. This possible interference will decrease over time as the population of wideband radios ages and decreases.

Further information and updates are available from the Australian Communications and Media Authority (ACMA) at www.acma.gov.au and the Ministry of Economic Development (MED), Radio Spectrum Management at www.rsm.govt.nz.

Standard Communications Contract Warranty Against Defects

This warranty against defects is given by Standard Communications Pty Ltd ACN 000 346 814 (We, us, our or GME). Our contact details are set out in clause 2.g.

1. Consumer guarantees

- a. Our goods come with guarantees that cannot be excluded under the Australian Consumer Law. You are entitled to a replacement or refund for a major failure and for compensation for any other reasonably foreseeable loss or damage. You are also entitled to have the goods repaired or replaced if the goods fail to be of acceptable quality and the failure does not amount to a major failure.
- b. To the extent we are able, we exclude all other conditions, warranties and obligations which would otherwise be implied.

2. Warranty against defects

- a. This warranty is in addition to and does not limit, exclude or restrict your rights under the Competition and Consumer Act 2010 (Australia) or any other mandatory protection laws that may apply.
- b. We warrant our goods to be free from defects in materials and workmanship for the warranty period (see warranty table) from the date of original sale (or another period we agree to in writing). Subject to our obligations under clause 1.b, we will at our option, either repair or replace goods which we are satisfied are defective. We warrant any replacement parts for the remainder of the period of warranty for the goods into which they are incorporated.
- c. To the extent permitted by law, our sole liability for breach of a condition, warranty or other obligation implied by law is limited.
 - (a) in the case of goods we supply, to any one of the following as we decide –
 - (i) the replacement of the goods or the supply of equivalent goods;
 - (ii) the repair of the goods;
 - (iii) the cost of repairing the goods or of acquiring equivalent goods;
 - (iii) the cost of repairing the goods or of acquiring equivalent goods;
 - (b) in the case of services we supply, to any one of the following as we decide –
 - (i) the supplying of the services again;

- (ii) the cost of having the services supplied again.
- d. For repairs outside the warranty period, we warrant our repairs to be free from defects in materials and workmanship for three months from the date of the original repair. We agree to re-repair or replace (at our option) any materials or workmanship which we are satisfied are defective.
- e. We warrant that we will perform services with reasonable care and skill and agree to investigate any complaint regarding our services made in good faith. If we are satisfied that the complaint is justified, and as our sole liability to you under this warranty (to the extent permitted at law), we agree to supply those services again at no extra charge to you.
- f. To make a warranty claim you must, before the end of the applicable warranty period (see warranty table), at your own cost, return the goods you allege are defective, provide written details of the defect, and give us an original or copy of the sales invoice or some other evidence showing details of the transaction.
- g. Send your claim to:
Standard Communications Pty Ltd.
PO Box 96 Winston Hills, NSW 2153, Australia.
Tel: (02) 8867 6000 Fax: (02) 8867 6199
Email: servadmin@gme.net.au
- h. If we determine that your goods are defective, we will pay for the cost of returning the repaired or replaced goods to you, and reimburse you for your reasonable expenses of sending your warranty claim to us.

What this warranty does not cover

This warranty will not apply in relation to:

- a. goods modified or altered in any way;
- b. defects and damage caused by use with non Standard Communications products;
- c. repairs performed other than by our authorised representative;
- d. defects or damage resulting from misuse, accident, impact or neglect;
- e. goods improperly installed or used in a manner contrary to the relevant instruction manual; or
- f. goods where the serial number has been removed or made illegal.

Warranty period

We provide the following warranty on GME and Kingray products. No repair or replacement during the warranty period will renew or extend the warranty period past the period from original date of purchase.

Product type	Warranty period
477 MHz UHF CB handheld radios	2 years
Li-ion battery packs	1 year

Table of Contents

Preface	2
Copyright Notice	2
Safety Information	2
Important Information Concerning UHF CB Radio	2
Standard Communications Contract Warranty Against Defects.....	3
Record of Amendments.....	5
Emergency Channels	9
Telemetry Channels	9
Important Advice	9
Accessories Supplied	10
TX677	10
TX677TP	10
Optional Accessories	10
Features	11
Controls	12
LCD Icons	13
Charging the Battery	14
Removing the Battery Pack	14
Refitting the Battery Pack.....	14
Charging the Battery Pack.....	15
Charging the TX677 Single Unit.....	15
In-Vehicle Charging	15
Charging the TX677 Twin Pack	16
Battery Usage	17
Battery Low Alert	17
Conserving Battery Power.....	17
Standby Mode.....	17
Use CTCSS/DCS	17
Avoid Scanning.....	17

Use Low Transmit Power	18
General Operation	18
Turning the Radio On/Off.....	18
Adjusting the Volume.....	18
Display Lighting	18
Receiving Signals.....	18
Transmitting	19
Time-out Timer.....	19
Selecting Channels.....	19
Squelch	19
Keypad Lock	20
Duplex Operation.....	20
Factory Reset.....	21
Scanning	21
Adding or Removing Channels.....	21
Scanning for Channels.....	21
Scanning Features.....	22
CTCSS, DCS and Silent Mode	22
Menu Options.....	23
Using the Menu	23
Duplex Mode Selection.....	24
CTCSS and DCS Code Selection	24
Transmitter Power.....	25
VOX Settings.....	26
Squelch Level Setting	26
Roger Beep Tone	27
Button Beep	27
Call Alarm Selection	27
Dual Watch.....	28
Dual Watch Operation	28
Specifications.....	32
General	32
Power Supply	32

Receiver	32
Transmitter.....	32

Emergency Channels

The ACMA has allocated channels 5/35 for emergency use only. Channel 5 is the primary Simplex Emergency Channel. Where a channel 5 repeater is available, you should select Duplex on channel 5.



Channel 35 is the input channel for the channel 5 repeater. Therefore channel 35 should also not be used for anything other than emergency transmissions.

Telemetry Channels

ACMA regulations have allocated channels 22 and 23 for telemetry-only applications and have prohibited the transmission of speech on these channels. Consequently the radio has a transmit-inhibit applied to channels 22 and 23.

In the event that additional telemetry/telecommand channels are approved by the ACMA, these channels shall be added to those currently listed where voice transmission is inhibited. Currently, transmissions on channels 61, 62 and 63 are also inhibited and these channels are reserved for future allocation.

Important Advice

- **Read all instructions** carefully and completely before operating your radio and retain this manual for future reference.
- **Never** connect the radio to a power source other than the supplied battery. This may damage your radio.
- **Do not** place your radio in front of a vehicle airbag.
- **Do not** use your radio with a damaged antenna.
- **Do not** attempt to modify your radio in any way.
- **Always** charge your radio at normal room temperature.
- **Always** switch off your radio where notices restrict the use of two-way radio or mobile telephones.
- **Use only** GME approved rechargeable battery packs with the supplied charger.
- **Avoid** storing or charging your radio in direct sunlight.
- **Avoid** storing or using your radio where temperatures are below -20°C or above +60°C.

Accessories Supplied

TX677

The following items are supplied as part of the TX677 radio set:

- TX677 radio
- Belt clip (MB047)
- Li-ion battery pack - 1600 mAh (BP021)
- AC adaptor (PS003)
- USB/Micro USB lead (LE061)
- Removable flexible antenna (AE4025)

TX677TP

The following items are supplied as part of the TX677TP radio set:

- 2 x TX677 radios
- 2 x Li-ion battery packs (1600 mAh) (BP021)
- 2 x belt clips (MB047)
- Twin desktop charger (BCD017)
- AC adaptor (PS003)
- 12V vehicle charger (BCV010)
- USB/Micro USB lead (LE06i)
- 2 x Removable flexible antenna (AE4025)

Optional Accessories

The following optional accessories are available as part of the TX677 radio set:

- Twin desktop charger (BCD017)
- USB 12V vehicle charger (BCV010)
- Leather carry case (LC008)
- Ear microphone (HS009)
- Speaker microphone (MC007)
- Clear acoustic tube and lapel microphone (HS010)



Instruction manuals are available online at
<https://www.gme.net.au/manuals-and-brochures.aspx>

Features

Feature	Description
Transmit (TX)	2.0/0.5 watt RF power: Selectable transmitter power allows you to conserve battery power when transmitting in close range by using the Low Power setting.
	Individually programmable Duplex function: User selectable for only those individual channels in your area that have repeaters, leaving others free for use as extra simplex channels.
Receive (RX)	80 [†] channels 477 MHz UHF CB.
	Power Save feature: Conserves battery power by sleeping during periods of inactivity.
	Calling Tone and Roger Beep: Alerts you to incoming calls.
	Signal receive indicator.
Scanning and Memory Functions	Microprocessor controlled frequency synthesiser: Allows user programmable control of scanning, channel memories and selected feature options.
	Programmable scan function: Scans up to 80 UHF CB channels.
	Dual Watch: Monitors two channels simultaneously.
Privacy Functions	CTCSS & DCS: A built-in Continuous Tone Coded Squelch System and a Digital Coded Squelch option provide quiet channel operation.
Physical Properties	Flexible antenna.
	Rugged construction.
User Controls and Interface	Keypad Lock: Prevents accidental button presses.
	Backlit LCD: For night viewing.

[†] Refer the preface for important information concerning the UHF CB radio.

Controls

This section provides figures and a table that describes various parts of the TX677 radio.

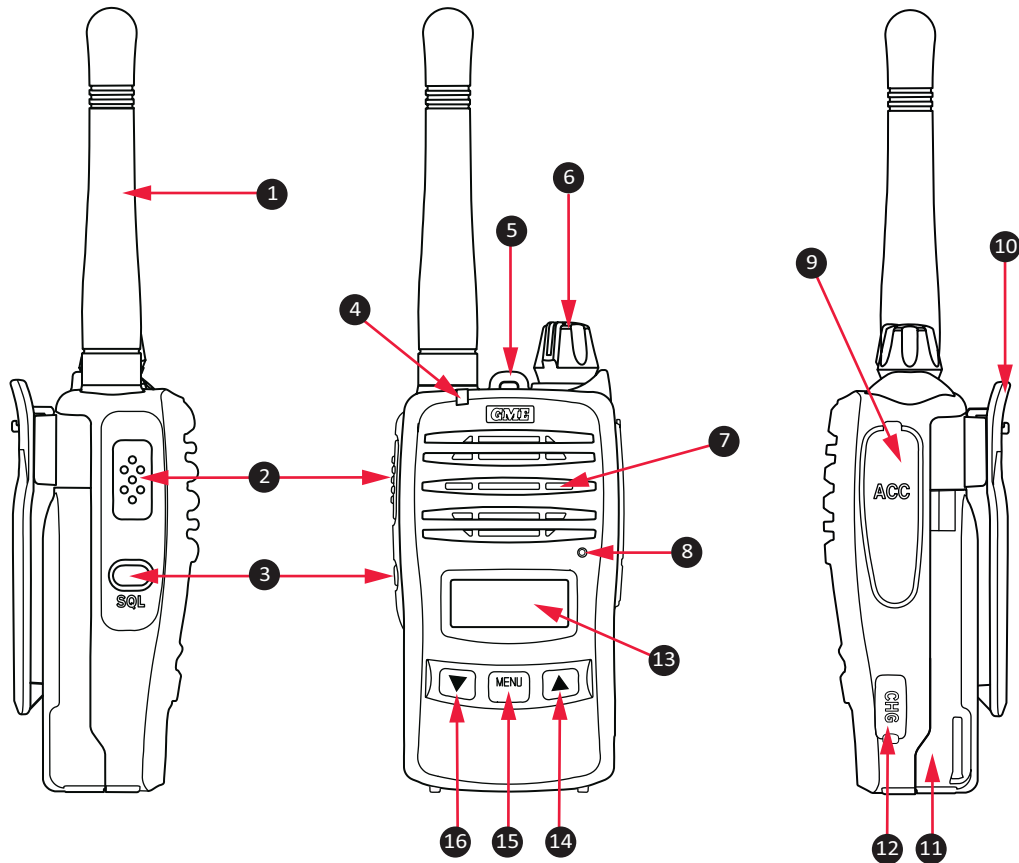

The table that follows is a numbered description of the parts of the TX677 radio, as labeled in the diagram above.

Label No.	Description	Label No.	Description
1	Antenna	9	Accessory Jack
2	PTT (Push to Talk) Switch	10	Belt Clip
3	Squelch/Silent/Memory Key	11	Battery
4	Indicator LED	12	USB Charge Socket
5	Lanyard Mount	13	LCD Screen
6	On/Off Switch and Volume control	14	Channel up key
7	Speaker	15	Menu/Function Key
8	Microphone	16	Channel down key

LCD Icons

The following figure and table below describes the icons on the LCD screen of the TX677 radio.

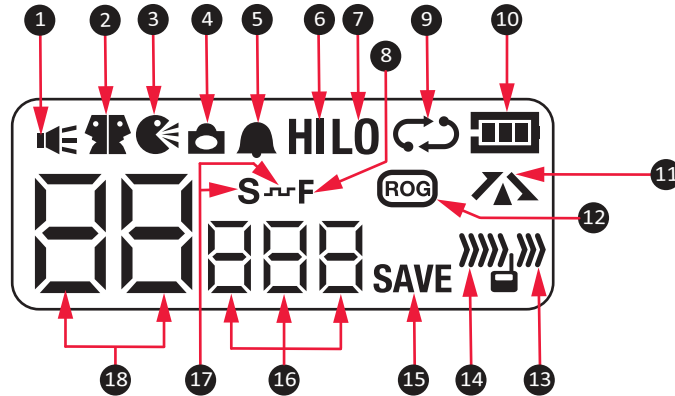

The table that follows is a numbered description of the icons on the LCD screen, as labeled in the diagram above.

Label No.	Description	Label No	Description
1	Monitor icon: Appears when the Squelch is open.	10	Battery icon: Displays battery charge level.
2	Dual Watch icon: Appears when Dual Watch is active.	11	Duplex icon: Appears on channels where Duplex is enabled.
3	VOX icon: Appears when VOX mode is active.	12	Roger Beep icon: Appears when the Roger Beep tones are active.
4	Key Lock icon: Appears when the keypad is locked.	13	Transmit icon: Appears when transmitting.
5	Button Beep icon: Appears when button confirmation tones are on.	14	Receive icon: Appears when receiving signals.
6	High Power icon: Appears when High TX power is selected.	15	Power Save icon: Appears when the radio is sleeping.
7	Low Power icon: Appears when Low TX power is selected.	16	CTCSS/DCS display: Displays the selected CTCSS or DCS tone when Silent mode is active.
8	Function icon: Appears when the function 'F' key is pressed to activate secondary functions.	17	CTCSS/DCS Silent icons: Indicates a CTCSS or DCS tone has been set in the menu.
9	Scan icon: Flashes when radio is scanning.	18	Channel display: Displays the selected channel in use.

Charging the Battery

The TX677 is powered by a 3.7V 1600mAh Li-ion battery pack. The battery pack should be fully charged before being used for the first time to ensure maximum capacity is available.

Removing the Battery Pack

1. Ensure that your radio is switched off.
2. Hold the radio upside down.
3. Using your fingernail, slide the battery catch towards the front of the radio to release the battery then slide the battery towards you. The battery pack should separate from the radio.

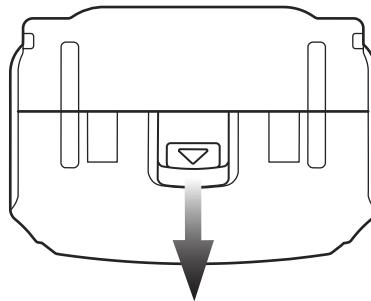

Slide to release

Refitting the Battery Pack

1. Ensure that your radio is switched off.
2. Align the slots in the battery pack with the battery guides on the back of the radio.
3. Slide the battery pack upwards as far as it will go until it clicks.

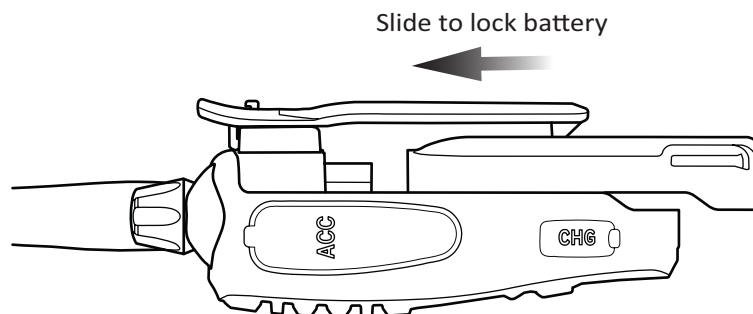

Slide to lock battery

Charging the Battery Pack



While the battery is charging, the indicator LED on the radio will light red and the battery icon on the display will animate to show the battery is charging. Once the battery is fully charged, the radio's indicator LED will change to green and the battery icon will show the full charge state.

Charging the TX677 Single Unit

The TX677 is supplied with a 240V AC adaptor and a USB lead. The AC adaptor will charge a fully discharged 1600mAh battery pack to full capacity in around 4 hours.

To charge the radio:

1. Plug the AC adaptor into a 240V AC outlet.
2. Plug the USB lead into the USB socket on the AC adaptor and the micro USB connector into the charging socket on the side of the radio.

The radio will begin charging. During this time the radio's indicator LED will light red and the battery icon on the display will animate. Once the battery is fully charged, the indicator LED will change to green and the battery icon will show the fully charge state.

In-Vehicle Charging

A 12V vehicle charger is available as an optional accessory. This will also charge your radio's battery to full capacity in around 4 hours using 12V DC from your vehicle's accessory socket.

Charging the TX677 Twin Pack

The TX677 Twin Pack is supplied with a dual desktop charger, 240V AC adaptor, 12V vehicle charger and a USB lead. Using the AC adaptor, the dual desktop charger will charge two fully discharged 1600 mAh battery packs to full capacity in around 4 hours.

If using the 12V vehicle charger with the dual desktop charger, two fully discharged 1600 mAh battery packs can be charged to full capacity in around 8 hours (with radios switched off).



When using the 12V vehicle charger to charge two radios via the dual desktop charger, we recommend switching both radios off while charging to ensure the batteries reach their full charge in the allotted 8 hour period. If one or more radios remain switched on during the charging cycle the batteries will achieve close to their full charge in the allotted time but the indicator LED may not switch to green. This is due to the lower charge current available from the 12V vehicle chargee.

Both the AC charger and 12V vehicle charger can also be used to directly charge a single TX677 radio in around 4 hours.

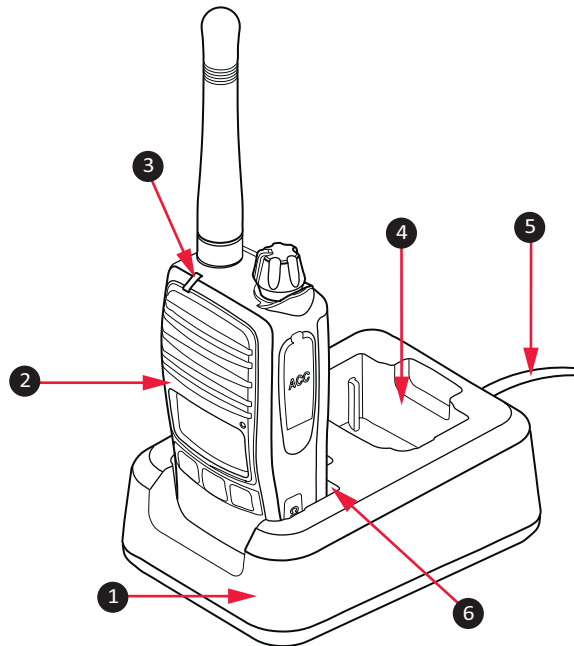

The table that follows is a numbered description of the parts of the TX677 and dual desktop charger, as labeled in the diagram above.

Label No.	Description	Label No	Description
1	Desktop charger	4	Rear cradle
2	TX677	5	USB lead from AC or 12V adaptor
3	Indicator LED	6	Front cradle

Battery Usage

The time taken to discharge the battery pack will depend on how you use the radio. The battery pack supplied is powerful enough for up to 20 hours of use under average conditions using low power. The sections that follow provide directions and recommendations on the optimal use of the battery pack.

Battery Low Alert

When the battery icon blinks on the radio's display, the battery level is low and the battery pack should be recharged.

Conserving Battery Power

The radio has built-in power saving features to help you get the maximum amount of time between charges from your Li-ion battery pack. If you need to operate your radio in a situation where you require maximum battery life (e.g. a remote site where there is no convenient recharging facility nearby) the following hints can greatly reduce the amount of power drawn from the battery pack.

Standby Mode

The radio will automatically enter the Standby mode when it is inactive (i.e. not transmitting or receiving signals).

While in Standby mode it will still check for incoming signals but it will draw considerably less power from the battery pack. As soon as a signal is heard or the keys are pressed the radio will 'wake up' again. This Standby mode is automatic and by itself can extend the battery life by many hours.

Use CTCSS/DCS

If you are expecting to receive signals on a busy channel, you can program that channel for CTCSS/DCS operation and get the other person to call you using the same CTCSS/DCS tone. Your radio will then remain in Standby and ignore all other signals until your selected CTCSS/DCS tone is received.

Avoid Scanning

The radio draws more power from the battery pack when scanning than when monitoring a single channel. This is because it must 'wake up' more often to monitor each channel for activity. In addition, scanning increases the chance of finding a signal thereby keeping the receiver 'awake' and the Squelch open more often.

Use Low Transmit Power

The transmitter has both high and low power settings. If you are only operating over short distances, are in a reasonably high location or are close to a local repeater, try using the Low transmitter power setting. This reduces the transmitter power to 0.5 watts which increases the talk time available.

General Operation

Turning the Radio On/Off

1. Rotate the **Volume** control clockwise past the click to turn the radio on.
2. Rotate the **Volume** control counter-clockwise past the click to turn the radio off again.

Adjusting the Volume

With the unit powered on, rotate the **Volume** control clockwise to increase the volume and counter-clockwise to decrease the volume.

Display Lighting

The LCD backlighting activates automatically whenever a key is pressed and turns off automatically after about 5 seconds.

Receiving Signals

While the radio is not receiving signals, it will remain in 'standby' mode to conserve battery power and 'Save' will be displayed. When a signal is received, the LED indicator on the upper edge of the radio will light green and the  icon will appear on the display. Adjust the **Volume** control for a comfortable listening level.

If the incoming signal is encoded with a CTCSS or DCS tone matching the one set in your radio, the LED indicator will light orange and you will be able to hear the signal in the speaker. If the LED indicator lights green and the  icon appears but you cannot hear the signal, it is likely that the incoming signal is using a different CTCSS or DCS tone to that selected in your radio (see Menu options for more details on setting CTCSS/DCS tones).

If no further signals are received, the unit will return to 'standby' mode after a few seconds.

Transmitting

To transmit:

1. Press and hold the **PTT (Push-To-Talk)** switch. The other radio you are talking to must be set to the same channel.
2. Hold the radio approximately 5-8 cm from your mouth with the antenna vertical and speak into the built-in microphone.
3. While the **PTT** switch is pressed, the LED indicator on the upper edge of the radio will light red and the  icon will appear on the LCD.
4. When you have finished speaking, release the **PTT** switch to receive incoming signals (it is not possible to transmit and receive at the same time). If no further signals are received, the unit will revert to 'Standby' mode.



The PTT switch can also be used to transmit a Call Alarm Melody.

When the call alarm melody is enabled (see Menu options for more details on Call Alarm settings), pressing the **PTT** switch twice quickly will play the call alarm melody in the speaker of other radios on the same channel to alert them to your call. During this time the  icon is displayed and the LED indicator will light red for about 5 seconds. The call alarm can only be sent once per minute.

Time-out Timer

The radio has a built-in time-out timer that automatically limits transmissions to a maximum of 3 minutes of continuous operation. This feature is required by the ACMA to prevent accidental blocking of the frequency should your PTT switch become jammed or be otherwise pressed accidentally. When the time-out timer activates, the radio will beep and 'tot' is displayed briefly on the LCD. Normal operation will be restored once the PTT switch is released.

Selecting Channels



1. In the 'Standby' mode, press the **▲** key to step up one channel or the **▼** key to step down one channel.
2. Press and hold the **▲** or **▼** keys to quickly scroll through the channels.

Squelch

The Squelch is used to eliminate the background noise when there are no signals present. When the squelch is open the receiver's background noise can be heard. When the squelch is closed the receiver remains quiet while there are no signals present but any incoming signals will override the squelch and be heard in the speaker.

To open the squelch:

Briefly press the **SQL** key. This will allow you to check the current channel for activity before transmitting, particularly if you have CTCSS/DCS enabled.

When the squelch is open, the LED indicator on the upper edge of the radio will light green and the  and  icons will appear on the display. During this time you will hear static or hiss if the channel is clear. Do not transmit if you hear any signals.

To close the squelch:

Briefly press the **SQL** key again.



The squelch sensitivity is preset in the Menu – Squelch Level setting (see Menu options for more details on setting the squelch sensitivity).

Keypad Lock

The Keypad Lock disables the keys to prevent accidental key presses from changing the preferred settings of the radio. When the keys are locked, the  icon is displayed and all key presses are ignored except for the PTT switch, SQL and the Keypad unlock sequence.

To lock the keypad:

Press the **F** key (the F icon will appear) then hold the **▼** key. The  icon will appear on the display.

To cancel the keypad Lock:

Press the **F** key then hold the **▼** key until the radio beeps. The  icon will disappear.

Duplex Operation

Duplex operation allows the radio to transmit on a different frequency to that which it receives. This allows operation through repeater stations in your area. Repeaters automatically re-transmit your signal over a much wider area, providing greatly increased range. The Duplex mode only works on designated repeater channels 1 – 8 and 41 – 48. With Duplex selected on one of these channels, your radio actually transmits 30 channels higher than it receives. For example, if Duplex is selected on channel 1, your radio will receive on channel 1 but will transmit on channel 31.

Duplex can be enabled or disabled on individual channels. When Duplex is enabled on the selected channel,  is displayed.

The Duplex mode is set through the Menu. Please refer the menu options in the Menu section further in this manual.

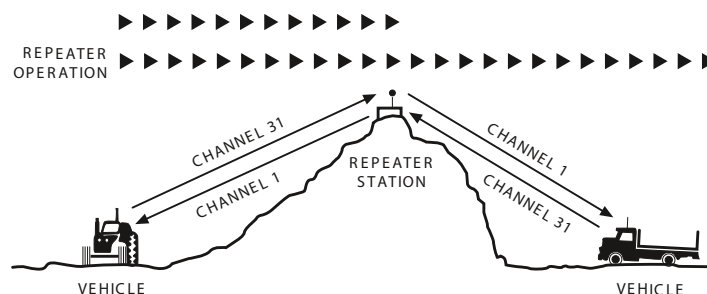

Figure 1 - Simple/Duplex Range Comparison

Factory Reset

A factory reset clears any settings you have made to your radio, and restores it to the default factory settings.

To perform a factory reset, press and hold the **Menu** and **SQL** keys simultaneously while switching the radio on.

Scanning

Channel scanning allows you to monitor all channels for incoming signals.





While the radio is scanning, the Menu setting key is disabled.



Adding or Removing Channels

To select channels for scanning:

Press the **▲** or **▼** keys to select the desired channel.

1. If the  icon is visible, the selected channel is already in the Scan Memory. Press **F** followed by **SQL** to remove the channel from the scan memory. A low beep will be heard and the  icon will disappear.
2. If the  icon is not visible the selected channel is not presently in the scan memory. Press **F** followed by **SQL** to add the channel to the scan memory.



Scanning for Channels

1. To scan for channels, briefly press **F** followed by the **▲** key. The  icon will flash and the channel numbers will change as the radio scans through the channels.
2. To change the scan direction while scanning, briefly press the **▲** or **▼** keys.
3. To stop scanning, briefly press **F** followed by the **▲** key. The  icon will stop flashing and the radio will return to normal operation.



There must be at least 2 channels stored in the scan memory. If not, the radio will not scan.

Scanning Features

- If a signal is received, the scan is paused allowing you to transmit and receive on that channel. During this time the  icon will continue to flash to show that the scan is still active. Once the channel has been inactive for 5 seconds the scan will automatically resume.
- Pressing the **PTT** switch while the radio is scanning will jump to the working channel allowing you to transmit and receive on that channel (the working channel is the channel the radio was on at the time the scan was activated). During this time the  icon will continue to flash to show that the scan is still active. Once the working channel has been inactive for 5 seconds the scan will automatically resume.
- If the scan is paused on a busy channel that you don't wish to listen to, press the **▲** or **▼** keys to skip over the channel and continue scanning.



The Scan mode will reduce the overall battery life because the 'Standby' (battery saver) feature is overridden. If the battery is running low you should avoid scanning to conserve power.

CTCSS, DCS and Silent Mode

CTCSS (Continuous Tone Coded Squelch System) and DCS (Digital Coded Squelch) are similar squelch quieting systems that allow groups of users to share the same channel without disturbing each other. The CTCSS system uses 1 of 50 low frequency tones to open and close the squelch on the radio. The DCS system is similar to CTCSS but uses 1 of 104 digital codes to control the squelch.

When CTCSS or DCS is enabled on your radio, only signals that are using the same tone or code as your radio will be heard in the speaker and the squelch will remain closed to all other signals.



CTCSS and DCS codes do not prevent others from hearing your transmission.

CTCSS/DCS tones are switched off by default.

To use CTCSS/DCS you must first enable a suitable CTCSS/DCS code using the menu (see Menu options for more details). Your choice of CTCSS or DCS will largely depend on which is currently being used by other radios in your group. If neither system is currently in use, you can make your own choice. There is no difference in performance between the two systems. Once a CTCSS or DCS code has been enabled, the display will show **S** (for CTCSS) or **S-~~---~~** (for DCS). You can now make selected channels 'quiet' by enabling Silent mode on those channels.

To activate or deactivate silent mode on a channel:

1. Select the required channel.
2. Press and hold the **SQL** key. The selected CTCSS or DCS code will be displayed on that channel.

Channels that have Silent mode enabled will now remain quiet unless a signal containing your chosen code is received.

	<p>Silent mode cannot be activated unless a CTCSS or DCS code has been selected via the Menu key (See Menu options for more details). If CTCSS/DCS tones are set to 'Off', any attempt to activate the Silent mode will be ignored. When communicating with other radios using CTCSS or DCS, all radios must be switched to the same channel and have the same CTCSS or DCS code selected. To receive signals from radios that are not using CTCSS or DCS, you will need to disable Silent mode on that channel.</p>
---	---

Menu Options

The **Menu** key is used to adjust the various feature settings. The following table shows the order of these selections.

No.	Description	Symbol	Options
1	Duplex (channels 1 – 8 and 41 – 48 only)		on/oF
2	CTCSS and DCS code selection	ct/dt	oF/01 – 50/ 001 – 104
3	Transmitter power	Po	Hi/Lo
4	VOX settings	Uo	oF/1 – 3
5	Squelch level setting	Sq	Aut/1 – 5
6	Roger Beep setting	rb	oF/on
7	Button Beep selection	bP	oF/on
8	Call Alarm selection	CL	oF/1 – 5
9	Dual Watch channel	dU	oF/on 1 – 80

	<p>The duplex menu option will only appear when channels 1-8 or 41-48 are selected. CTCSS/DCS and transmit power settings are inhibited on channels 5/35 (emergency channel).</p>
---	---

Using the Menu

- To access the menu, press and hold the **Menu** key until the radio beeps. Menu options will appear in the order listed above.
- To step to the next menu item, press the **Menu** key again.
- To change options in selected menu, press the **▲** or **▼** keys.
- To store your selection and exit menu, press the **PTT** switch.

Duplex Mode Selection

The Duplex option only appears in the Menu if a repeater channel (1 – 8 or 41 – 48) is selected.

To enable Duplex on a repeater channel:

1. Select a repeater channel 1 – 8 or 41 – 48 using the ▲ or ▼ keys.
2. Press and hold the **Menu** key until the radio beeps. The ↕ icon will flash.
3. Press the ▲ or ▼ keys to toggle 'on' (duplex enabled) or 'oF' (duplex disabled) on the display.
4. Press the **PTT** switch to store your setting and exit the menu.

When Duplex is enabled on a repeater channel, the ↕ icon will be displayed on that channel.

CTCSS and DCS Code Selection

The radio is fitted with both CTCSS and DCS systems. There are 50 CTCSS tones and 104 DCS codes. The DCS codes and the CTCSS tones are accessed through the same menu (refer the following figure). When CTCSS tones are being selected 'ct' is displayed.

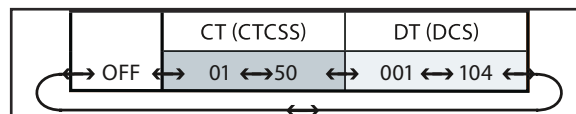

To access DCS codes:

Scroll past CTCSS tone 50 until 'dt' is displayed.

To select a CTCSS or DCS code:

1. Select the required channel.
1. Press and hold the **Menu** key until the radio beeps. 'ct' (for CTCSS) or 'dt' (for DCS) will be displayed.
2. Press the ▲ or ▼ keys to select the required tone/code.
3. To select CTCSS tones 01 to 50 press the ▲ or ▼ keys while 'ct' is displayed. When a CTCSS code is selected the S icon is displayed.
4. To select DCS codes, hold the ▲ key to scroll past CTCSS tone 50 until 'dt' is displayed. Now use the ▲ or ▼ keys to select the required DCS code 001 to 104. When a DCS code is selected the S↔ icon is displayed.
5. To return to CTCSS tones hold the ▲ or ▼ keys until 'ct' is displayed again.
6. To turn CTCSS/DCS tones off, hold the ▲ or ▼ keys to step to the end of the code list until 'oF' is displayed.
7. Press the **PTT** switch to confirm and store your selection. The S (CTCSS) or S↔ icon remains on the display to confirm the code system you have selected.

To enable silent mode on a channel:

1. Select the required channel.
2. Press and hold the **SQL** key for about 2 seconds. The selected code number will be displayed on that channel.
3. The selected channel will now remain silent unless a signal is received containing the chosen code.

	Silent mode will only be enabled on channels you select. Other channels will remain open to all incoming signals.
---	---

To disable silent mode on a channel:

1. Select the required channel. The CTCSS/DCS code will be displayed.
2. Press and hold the **SQL** key for about 2 seconds. The selected code number will disappear from the display on that channel. The selected channel will now be open to all incoming signals.

Transmitter Power

The transmitter power can be set to High or Low on a channel-by-channel basis (except 5/35).

To set the transmit power:

1. Select the required channel.
2. Press and hold the **Menu** key until the radio beeps.
3. Briefly press the **Menu** key repeatedly until 'Po' is displayed. 'Hi' or 'Lo' will be flashing.
4. Press the **▲** or **▼** keys to select the required power setting. Select 'Hi' for high power or 'Lo' for low power.
5. Press the **PTT** switch to confirm and store your selection.

The radio should now display the selected channel number along with the **Hi** or **Lo** icon to indicate the transmit power you have set on that channel.

VOX Settings

The VOX feature allows you to have hands-free conversations. When you speak, the microphone automatically detects your voice (or other nearby sound) causing the radio to transmit without the need to press the PTT switch.

To enable VOX operation:

1. Hold the **Menu** key for 2 seconds. The channel number will flash.
2. Briefly press the **Menu** key repeatedly until 'Uo' is displayed.
3. Press the **▲** or **▼** keys to set the VOX sensitivity from 1 (min) to 3 (max). A minimum setting requires a louder voice to activate the VOX while a maximum setting will activate the VOX with a much softer voice.
4. To disable the VOX completely, set the VOX sensitivity to 'oF'.
5. Press the **PTT** switch to confirm and store your selection.

When VOX is enabled, the  icon is visible on the display.



Using the radio in a noisy environment with the VOX sensitivity set to maximum could cause the radio to transmit unexpectedly. If this happens simply reduce the sensitivity setting.

Squelch Level Setting

The Squelch is designed to keep the radio quiet when there are no signals present. The squelch setting adjusts the sensitivity of the squelch to incoming signals. Higher squelch settings require stronger signals to overcome the squelch and be heard in the speaker while lower settings allow much weaker signals to be heard.



To set the squelch:

1. Hold the **Menu** key for 2 seconds. The channel number will flash.
2. Press the **Menu** key repeatedly until 'Sq' is displayed. The current squelch level will flash.
3. Press the **▲** or **▼** keys to adjust the squelch level from 1 (most sensitive) to 5 (least sensitive) or select 'AUT' (Auto) for an automatic setting.
4. Press the **PTT** switch to confirm and store your selection.

Roger Beep Tone

The Roger Beep is a tone that is automatically transmitted whenever the PTT switch is released. This tone serves to alert the receiving party that your transmission has ended.



To enable or disable the roger beep tone:

1. Press and hold the **Menu** key until the radio beeps.
2. Press the **Menu** key repeatedly until 'rb' is displayed. The  icon will be flashing.
3. Press the **▲** or **▼** keys to select 'on' or 'oF'.
4. Press the **PTT** switch to confirm and store your selection.
5. When the roger beep tone is enabled, the  icon will be displayed.

Button Beep

The Button Beep allows the radio to sound a confirmation beep whenever the keys are pressed. It also generates a confirmation tone whenever the radio is switched on.

To turn the button beep on or off:

1. Press and hold the **Menu** key until the radio beeps.
2. Press the **Menu** key repeatedly until 'bP' is displayed. The  icon will be flashing.
3. Press the **▲** or **▼** keys to select 'on' or 'oF'.
4. Press the **PTT** switch to confirm and store your selection.
5. When the Button Beep is enabled the  icon will be displayed and a beep will be heard whenever a key is pressed.

Call Alarm Selection

The radio provides 5 user-selectable Call Alarm melodies to alert other users to your incoming call. When enabled, the melody can be transmitted to another user where it will be heard in the speaker of the receiving radio.

To select your favourite call alarm melody:

1. Press and hold the **Menu** key until the radio beeps.
2. Press the **Menu** key repeatedly until 'CL' is displayed. Call number 1 – 5 or 'oF' will be flashing.
3. Press the **▲** or **▼** keys to preview (listen to) the 5 available Call Melodies (1 – 5).
4. To disable the call melodies, select 'oF'.
5. Press the **PTT** switch to confirm and store your selection.

To send the Call Alarm Melody:

Press the **PTT** switch twice quickly. The  icon will appear and the LED indicator will light red for a few seconds as the melody is sent. The melody will be heard in the speaker of the receiving radio.





The Call Alarm can only be sent once per minute.

Dual Watch

The Dual Watch mode lets you to monitor two channels at the same time. While in dual watch mode, the unit will monitor both the selected channel and a second dual watch channel.

To set the dual watch mode:

1. Use the **▲** or **▼** keys to choose the selected channel.
2. Press and hold the **Menu** key until the radio beeps.
3. Press the **Menu** key repeatedly until 'dU' is displayed. The  icon will be flashing.
4. Press the **▲** or **▼** keys to select the second 'dual watch' channel or select 'oF' to disable the dual watch mode.
5. Press the **PTT** switch to confirm and store your selection.

While dual watch is active, the  icon and LCD will alternate between the selected channel and the dual watch channel.

Dual Watch Operation

- If a signal is received on either channel, the radio will pause on that channel for as long as it remains busy, then resume the Dual Watch 5 seconds after the last transmission has ceased.
- To talk on the dual watch channel, press the **PTT** switch while the radio is paused on that channel then talk in the usual way.
- To talk on the selected channel, press the **PTT** switch while no signals are being received. The radio will switch to the selected channel. When you have finished your conversation the radio will resume the Dual Watch 5 seconds after the last transmission has ceased.

To stop Dual Watch, briefly press the **Menu** key followed by the **▲** key. This is equivalent to selecting 'oF' in the Dual Watch menu setting.

The table that follows details the CTCSS tone frequencies of the TX677 radio.

CTCSS Tone Frequencies							
No.	Frequency	No.	Frequency	No.	Frequency	No.	Frequency
1	67.0	14	107.2	27	167.9	40	159.8
2	71.9	15	110.9	28	173.8	41	165.5
3	74.4	16	114.8	29	179.9	42	171.3
4	77.0	17	118.8	30	186.2	43	177.3
5	79.7	18	123.0	31	192.8	44	183.5
6	82.5	19	127.3	32	203.5	45	189.9
7	85.4	20	131.8	33	210.7	46	196.6
8	88.5	21	136.5	34	218.1	47	199.5
9	91.5	22	141.3	35	225.7	48	206.5
10	94.8	23	146.2	36	233.6	49	229.1
11	97.4	24	151.4	37	241.8	50	254.1
12	100.0	25	156.7	38	250.3	–	–
13	103.5	26	162.2	39	69.4	–	–

The table that follows details the DCS tones of the TX677 radio.

DCS Tone Chart											
DCS	Code	DCS	Code	DCS	Code	DCS	Code	DCS	Code	DCS	Code
1	023	19	116	37	225	55	325	73	452	91	627
2	025	20	122	38	226	56	331	74	454	92	631
3	026	21	125	39	243	57	332	75	455	93	632
4	031	22	131	40	244	58	343	76	462	94	654
5	032	23	132	41	245	59	346	77	464	95	662
6	036	24	134	42	246	60	351	78	465	96	664
7	043	25	143	43	251	61	356	79	466	97	703
8	047	26	145	44	252	62	364	80	503	98	712
9	051	27	152	45	255	63	365	81	506	99	723
10	053	28	155	46	261	64	371	82	516	100	731
11	054	29	156	47	263	65	411	83	523	101	732
12	065	30	162	48	265	66	412	84	526	102	734
13	071	31	165	49	266	67	413	85	532	103	743
14	072	32	172	50	271	68	423	86	546	104	754
15	073	33	174	51	274	69	431	87	565	–	–
16	074	34	205	52	306	70	432	88	606	–	–
17	114	35	212	53	311	71	445	89	612	–	–
18	115	36	223	54	315	72	446	90	624	–	–

The table that follows details the UHF CB operating frequencies of the TX677 radio.

UHF CB Operating Frequencies					
CH	Frequency (MHz)	CH	Frequency (MHz)	CH	Frequency (MHz)
1	476.425	28	477.100	55	476.7875
2	476.450	29	477.125	56	476.8125
3	476.475	30	477.150	57	476.8375
4	476.500	31	477.175	58	476.8625
5	476.525	32	477.200	59	476.8875
6	476.550	33	477.225	60	476.9125
7	476.575	34	477.250	61	476.9375
8	476.600	35	477.275	62	476.9625
9	476.625	36	477.300	63	476.9875
10	476.650	37	477.325	64	477.0125
11	476.675	38	477.350	65	477.0375
12	476.700	39	477.375	66	477.0625
13	476.725	40	477.400	67	477.0875
14	476.750	41	476.4375	68	477.1125
15	476.775	42	476.4625	69	477.1375
16	476.800	43	476.4875	70	477.1625
17	476.825	44	476.5125	71	477.1875
18	476.850	45	476.5375	72	477.2125
19	476.875	46	476.5625	73	477.2375
20	476.900	47	476.5875	74	477.2625
21	476.925	48	476.6125	75	477.2875
22	476.950	49	476.6375	76	477.3125
23	476.975	50	476.6625	77	477.3375
24	477.000	51	476.6875	78	477.3625
25	477.025	52	476.7125	79	477.3875
26	477.050	53	476.7375	80	477.4125
27	477.075	54	476.7625		

	Emergency use only	11	Officially designated call channel
	Telemetry / Selcall use only. Voice transmission is inhibited as required by AS/NZS 4365.2011	40	Road channel
	Guard band channel. Transmission is inhibited as required by AS/NZS 4365.2011	18	Caravan and motor home
	Repeater input channels (Duplex)	10	4WD / Off road
	Repeater output channels (Duplex)		

Specifications

General

Type	Description
Frequency Range	476.425 – 477.4125 MHz
Channel Spacing	12.5 kHz
No of Channels	80, (75 voice, 2 telemetry RX only, 3 for future use).
CTCSS Codes	50
DCS Codes	104
Dimensions	(W x H x D): 52 mm x 90 mm x 36 mm (without antenna)
Complies with	AS/NZS 4365: 2011

Power Supply

Type	Description
Power Source	Li-ion rechargeable – 3.7V DC, 1600 mA
Operating Time	14 Hours (High Power)
	20 Hours (Low Power)
	(Transmit 5%, Receive 5%, Standby 90%)

Receiver

Type	Description
Usable Sensitivity:	-121 dBm
Maximum Audio Output:	>0.5 watt max. (8 Ohm)
Modulation Distortion:	<5% (1 kHz 70%)



Transmitter

Type	Description
Transmit Power:	Hi: 1.8 watts
	Lo: 0.5 watt



Specifications are typical unless otherwise indicated and may be subject to change without notice or obligation.



 1300 463 463  gme.net.au

A division of Standard Communications Pty Ltd.
Head Office: PO Box 96, Winston Hills, NSW 2153, Australia.
New Zealand: PO Box 58446 Botany, Auckland, 2163, NZ. T: (09) 274 0955.
All international enquiries email: export@gme.net.au