

KICKASS[®]

AGM POWER STATION USER MANUAL



NO DCDC MODEL

WITH DCDC MODEL

TABLE OF CONTENT

IMPORTANT SAFETY INSTRUCTIONS	1
OVERVIEW	2
GETTING STARTED	3
BATTERY TO USE	4
OPTIONAL ACCESSORIES	5
- MOUNTING TRAY	5
SWITCH/BUTTONS	6
CONNECTIONS	7
- OUTPUTS	7
- INPUT/OUTPUTS	8
TYPICAL DIAGRAMS	9
CONNECTING TO EXTERNAL CHARGERS	9
DCDC CHARGER MODEL	10
NON DCDC CHARGER MODEL	11
DIY VSR WIRING	11
DIY DCDC CHARGER WIRING	12
- MOUNTING NEAR BOX	12
- MOUNTING ON BOX	13
CONNECTING TO ALTERNATOR INPUT	15
- CONNECTING TO UNREGULATED SOLAR	15
TECHNICAL SPECIFICATIONS	16
FREQUENTLY ASKED QUESTIONS	17

IMPORTANT SAFETY INSTRUCTIONS

- For use with 12V rechargeable batteries only.
- Never attempt to recharge non-rechargeable batteries.
- The lid of the battery box must remain shut at all times whilst charging a battery or powering a device from an outlet.
- Do not allow any metal objects to fall into the battery box or enter any of the ports.
- Never insert anything other than a compatible electrical plug into any of the ports on the battery box.
- Ensure that the battery box is shut and the screws are tight before powering any devices.
- Do not try to jumpstart when using lithium batteries.

OVERVIEW

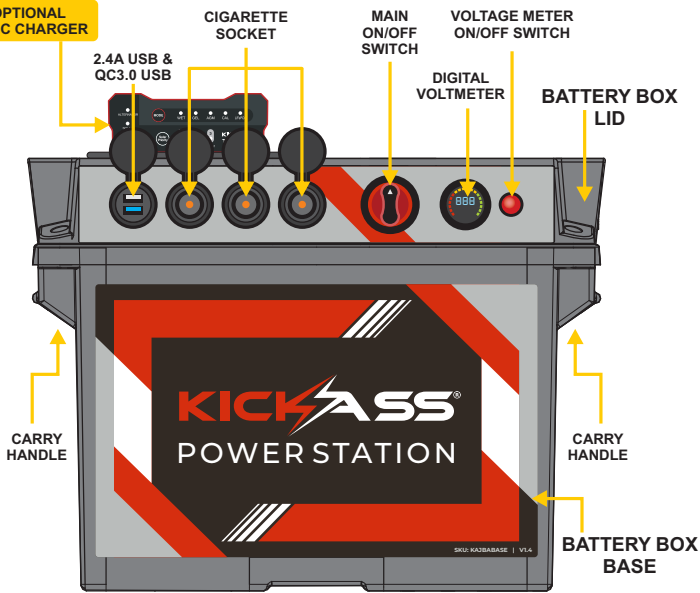

Material
ABS

Temperature Range
-10°C to +60°C

FRONT

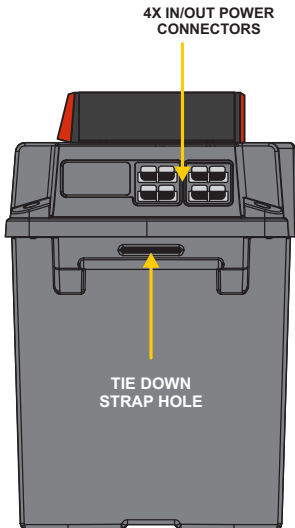
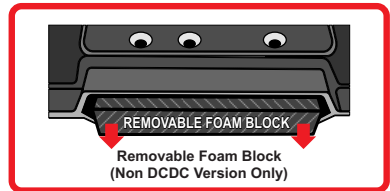

SIDE

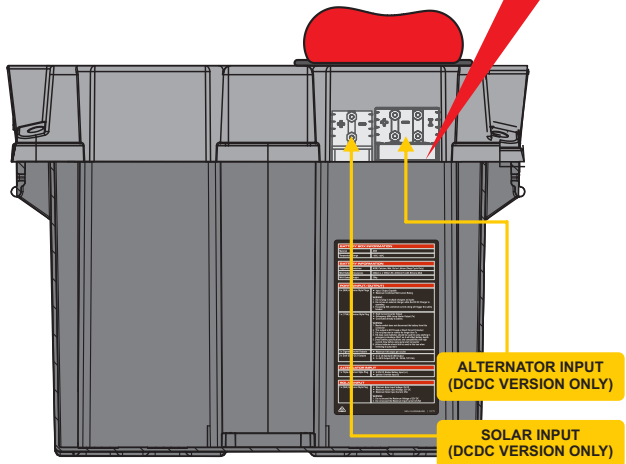

BACK

GETTING STARTED

NOTE: If your battery box base was shipped with a battery installed, skip to Step 3.

Step 1: Peel off the plastic film to expose the non-slip surface of the silicone pads.

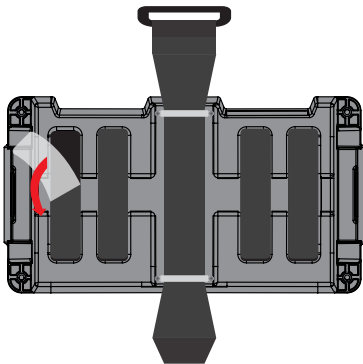

Note: the pads may be washed to regain stickiness.

Step 2: Lower your battery into the battery box base carefully, locating it as centrally as possible on the non-slip pads.



Step 3: Secure the battery in place by tightening the velcro strap over the battery.

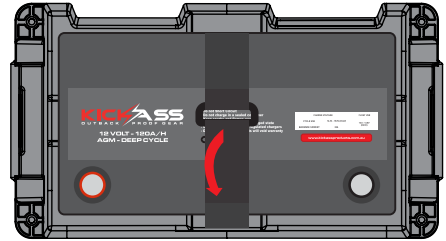

Step 4: Install the battery cables onto the terminal posts of the battery. Ensure the red cable is connected to the positive (+) terminal and black cable connected to the negative (-) terminal. For DCDC versions, also connect the thin black cable to the negative (-) terminal.

Tighten firmly but be sure not to over tighten the battery terminals.

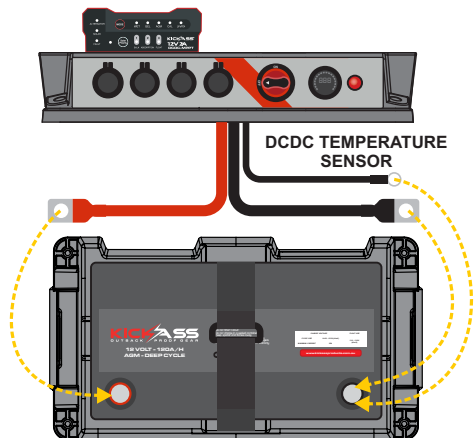

Step 5: Tuck cables in under battery box lid, lowering lid carefully onto box - ensuring the lid is correctly oriented.



Step 6: Install the 4 provided screws to fasten the lid to the base, being sure not to over tighten with the supplied allen key.



BATTERY TO USE

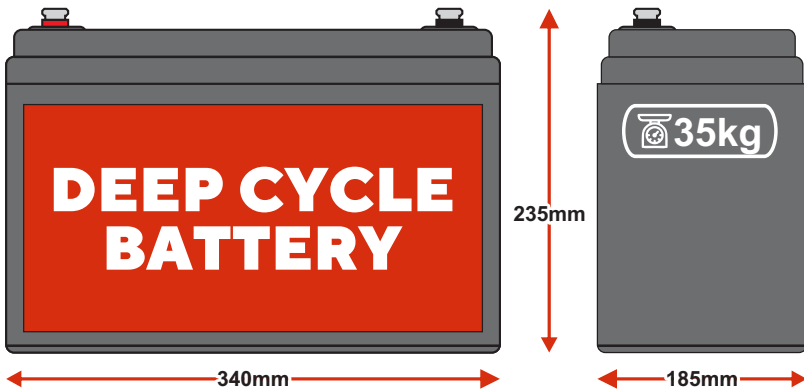

Max. Battery Dimensions:	340mm L x 185mm W x 235mm H (with Silicone Mat)
Max. Battery Weight:	35kg
Supported Chemistries:	AGM, Calcium, Wet, Gel or Lithium LiFePO4 (Deep Cycle Batteries)

OPTIONAL ACCESSORIES

MOUNTING TRAY (OPTIONAL)

Step 1:

Confirm install location of tray, drilling any required holes.

Install the strap under the tray, sliding the strap into the slots either side.

Ensure strap is oriented correctly so that the hooks face toward the Power Station when installed.

Securely affix the tray in position using bolts or screws, whichever is applicable.

Ensure that washers are used when installing the tray, to avoid damage.

Note: We do not provide the screws or bolts for this installation.

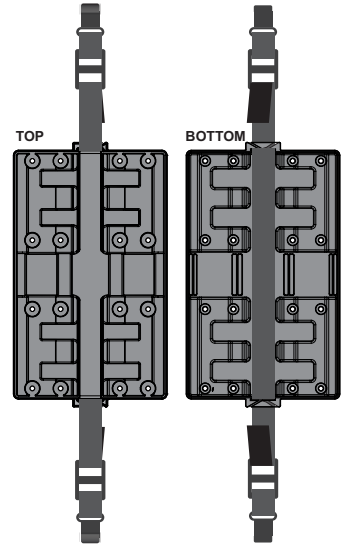

Step 2: Ensure straps are laying outside the tray before lowering the battery box carefully onto the tray. Attach each strap hook to the corresponding slot in the Power Station.

Step 3: For ease of tightening, place thumbs in each strap loop, pushing firmly downwards. The strap should tighten and hold the Power Station firmly in place.

To release, depress the buckle and pull the strap to loosen.

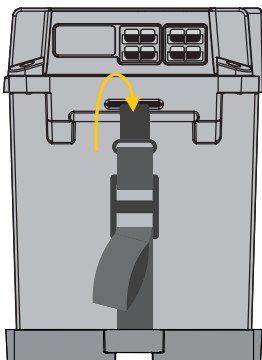

SWITCH/BUTTONS

The Master Switch

The master switch disconnects everything from the battery including the DC-DC Charger. Turning it off is a quick way to disconnect all devices to ensure your battery is not being drained.

Note: The DC-DC Charger + Solar Regulator cannot charge the internal battery while the Master Switch is in the OFF position, nor can an external charger.

If another, external battery is connected through one of the IN/OUT connectors, the DC-DC is able to charge that battery, even with the Master Switch in the OFF position - bypassing the internal battery.

The Voltmeter

The inbuilt voltmeter will display the voltage of your battery.

For an accurate voltage reading, disconnect all loads and charging sources from the power station and test.

Note: The battery voltage table on the top sticker of the battery box is to be used as a guide only, check your battery specifications if you want to be precise.

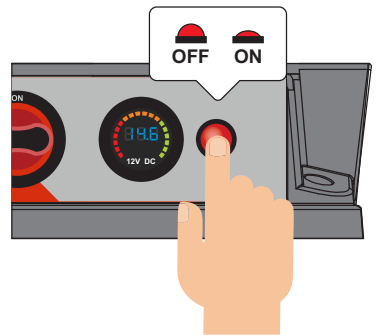
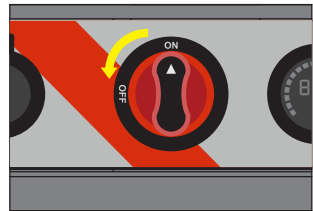
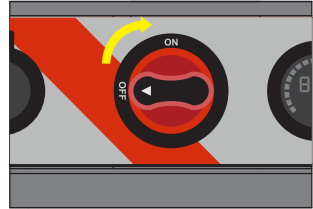

CONNECTIONS

► OUTPUTS

1 X DUAL USB / QC3.0 OUTPUTS

- 2.4A High Powered USB (White)
- Quick Charge QC 3.0 Ultra High Powered USB Outputs (5V/3.1A, 9V/2A, 12V/1.5A - Blue)

3 X CIGARETTE SOCKET OUTPUTS

- Maximum 10A output per socket

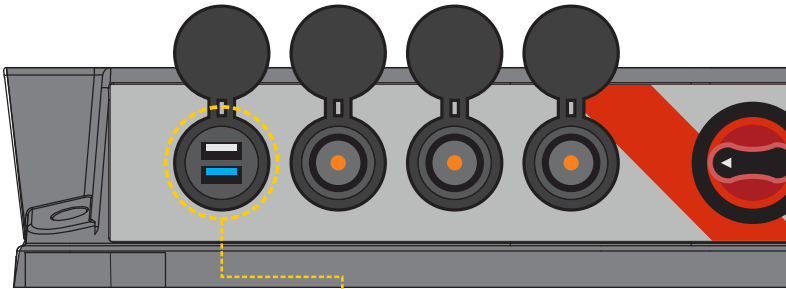

Dual USB / QC3.0 Outputs

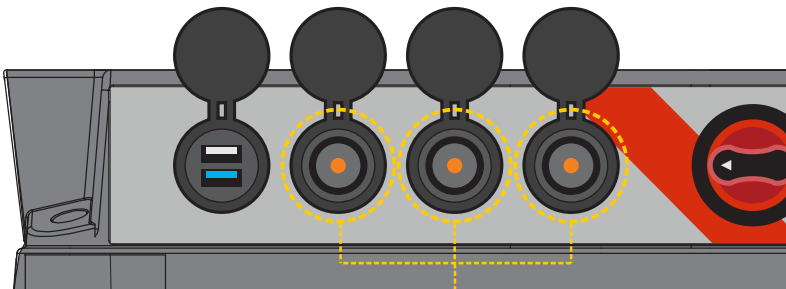

3 x Cigarette Socket Outputs

Benefits of Quick Charge

When paired with compatible devices, a Quick Charge-enabled charger delivers more power, allowing the connected device to charge faster. As one of the most widely used of the fast charging technologies, Quick Charge is already in many of your favorite smartphones. If your smartphone is Quick Charge 3.0-compatible, you can charge up to 80% in just 35 minutes.

To future-proof your chargers, each new Quick Charge generation is backwards compatible, meaning it will work with the generations that came before.

► INPUTS/OUTPUTS

4 X (50A) ANDERSON STYLE PLUGS

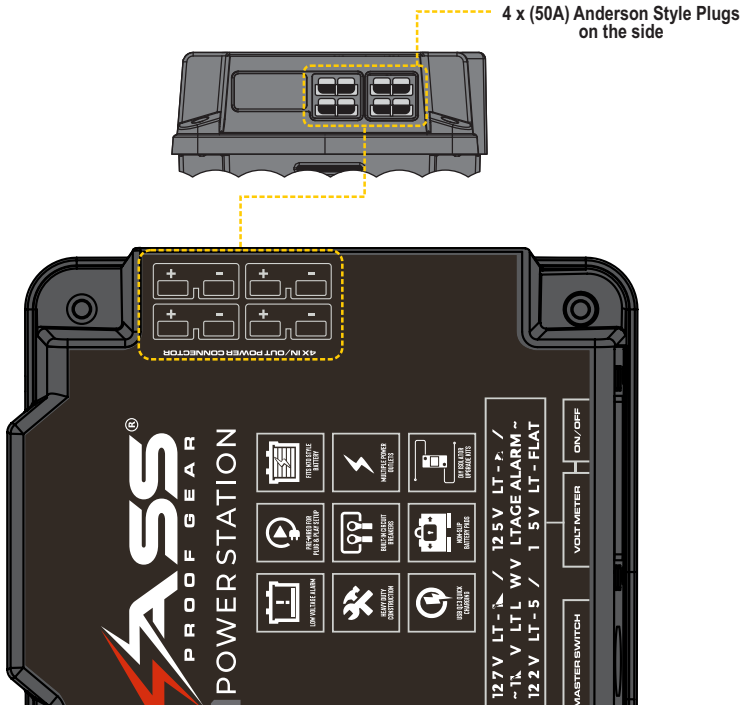

- Input / Output Capable.
- All Anderson Plugs combined must not exceed 50A total current.

WARNING:

1. Do not plug in multiple chargers as inputs.
2. Do not use an external charger while the DC-DC Charger is operating.
3. Exceeding 50A combined current rating will trigger the safety breaker. Safety breaker will auto-reset in time.

NOTE: THE 4 ANDERSON PLUGS INDICATED CANNOT EXCEED A TOTAL OF 50 AMPS COMBINED.

TYPICAL DIAGRAMS

Charging with External charges

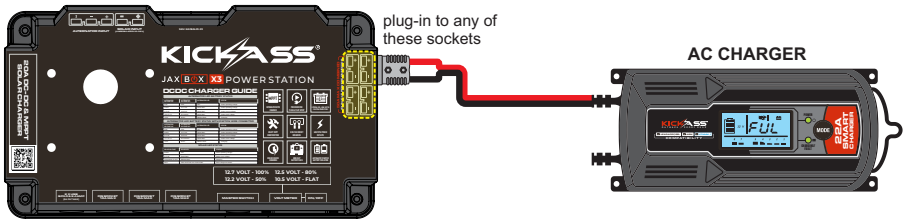
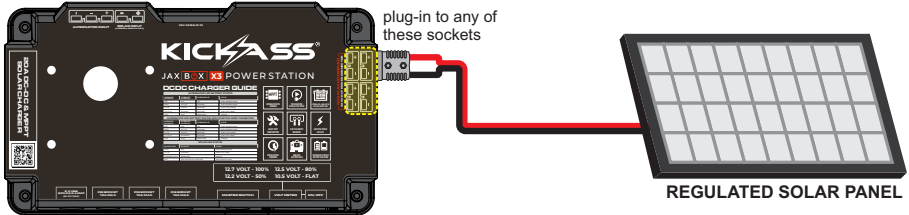

CONNECTING TO EXTERNAL CHARGERS

The KickAss Power Station may be charged in a number of ways:

- Connecting an AC charger to any of the in/out Anderson style connectors.
- Connecting a solar panel with regulator/controller to any of the in/out Anderson style connectors.
- Connecting alternator power to optional DCDC Charger in a vehicle.
- Connecting an unregulated solar panel input to optional DCDC Charger.
- Connecting the starter battery to a VSR wiring kit and then connecting to any of the in/out Anderson style connectors (non DCDC battery box only).

Warning:

- Connecting multiple chargers to the battery at any one time is not recommended.
- Do not connect an unregulated solar panel directly to the battery via any of the in/out connectors.

DCDC CHARGER MODEL

CONNECTING TO ALTERNATOR INPUT

The following information only applies to the KickAss Battery Boxes fitted with a DCDC Charger. For specific information regarding the operation of the DCDC Charger, refer to the specific charger manual.

The KickAss Power Station includes a built-in DC-DC Charger suitable for charging from a vehicle alternator.

The easiest way to connect the Power Station to your vehicle is by using the KickAss Plug & Play Wiring Kit (sold separately).

The triple Anderson style connector fitted to the Power Station interfaces with the KickAss Plug & Play Wiring Kit, providing a simple, quick release vehicle charging solution. This triple connector and cable provides alternator power to the DC-DC on the Power Station, along with an Ignition Source for charging in vehicles that are fitted with Smart or Temperature Compensating Alternator.

For more information on installing a Dual Battery Wiring Kit and Ignition Wire, please visit kickassproducts.com.au/support

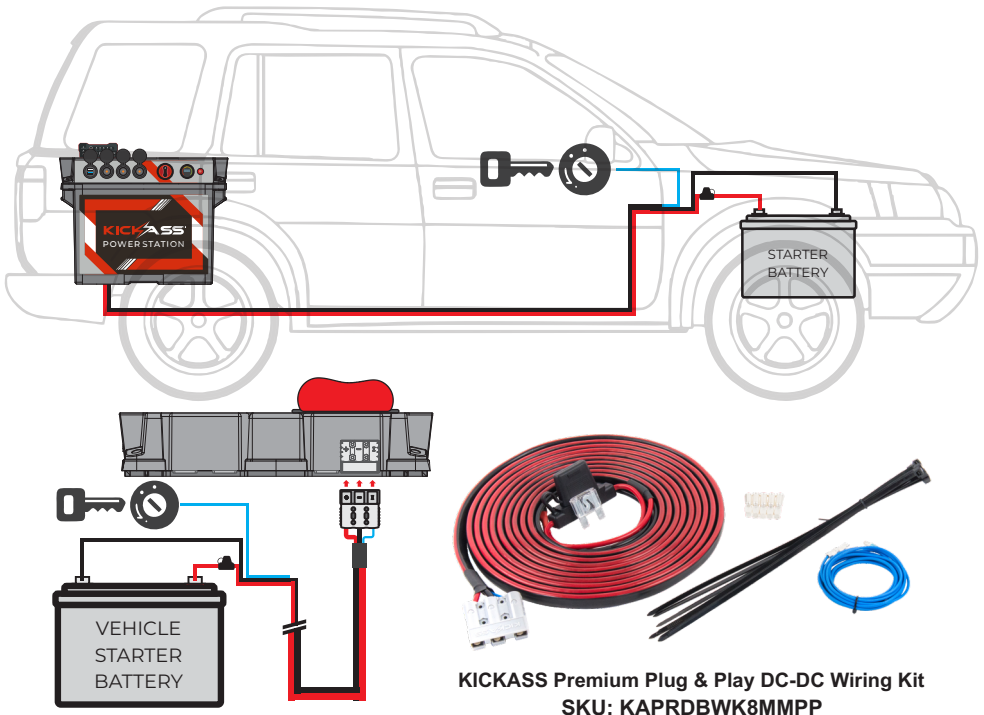

NON DCDC CHARGER MODEL

DIY VSR WIRING

The following information only applies to the KickAss Battery Boxes fitted without a DCDC Charger

The KickAss Battery Box allows you to create an all in one dual battery system. For vehicles without smart or temperature compensating alternators. The easiest way to connect the control hub to your vehicle with a voltage sensitive relay is by using the KICKASS Plug & Play Dual Battery System Wiring Kit & Dual Sensing VSR (sold separately).

The 6 Anderson style connector fitted to the control hub interfaces with the KickAss Plug & Play Wiring Kit, providing a simple, quick release vehicle charging solution. This connector and cable provides alternator power to your second battery through the battery box.

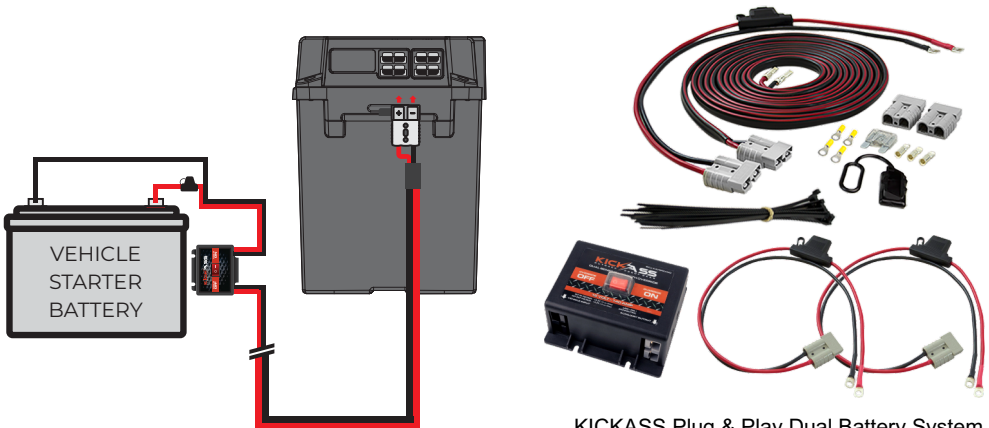
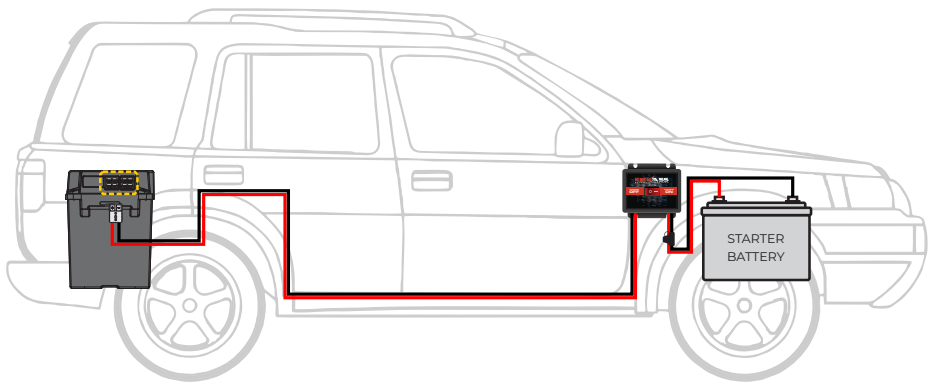

KICKASS Plug & Play Dual Battery System
Wiring Kit & Dual Sensing VSR
SKU: KADABE K8MMV SR2AND

DIY DCDC CHARGER WIRING

Note: Prior to undertaking any DIY Installation ensure your battery is disconnected and your lid is removed from the battery box base.

If you already have a DCDC Charger, there are a number of ways in which you can install it on the non DC DC version of the battery box.

Method One (Mounting near box)

If you have a mounting position for the DCDC charger in the vehicle, close to the battery box, simply crimp an Anderson style connector to the output of the DCDC charger and connect to any of the In/Out Anderson Style connectors. If required, blank two pin anderson style connectors can be purchased from the KickAss Store.

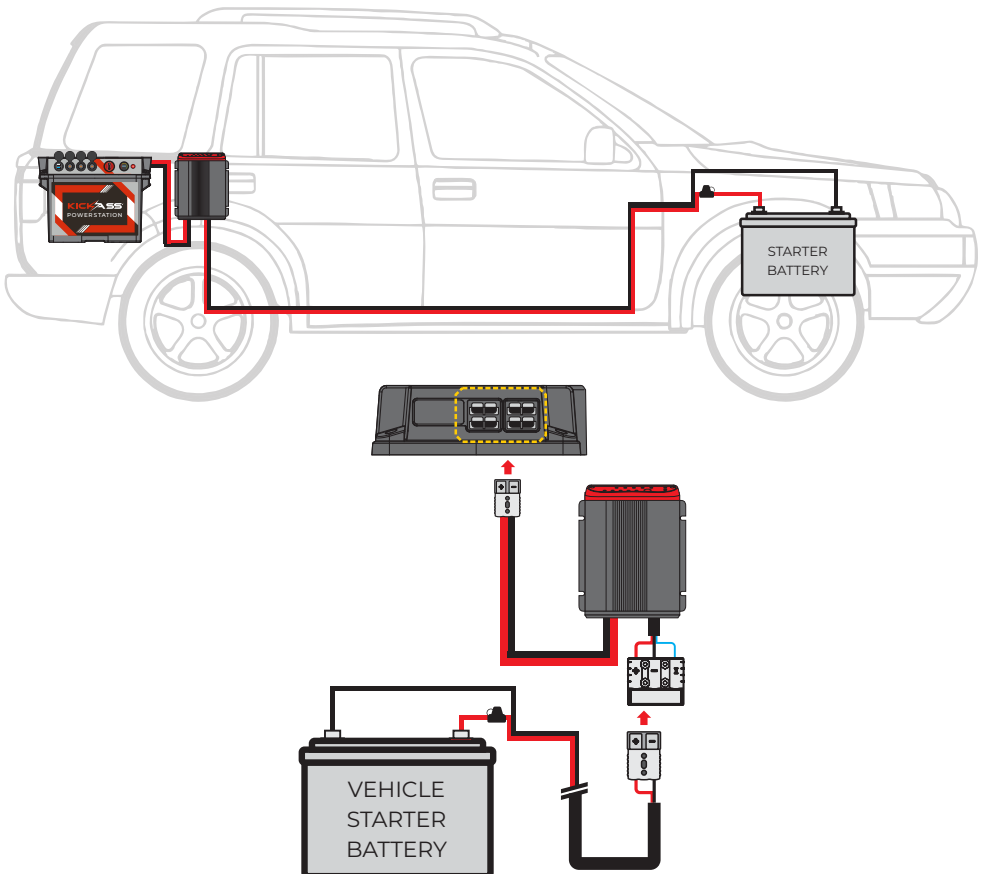

Method Two (Mounting on box)

1. Flip the battery box lid upside down, remove the 6 screws and carefully remove the cover revealing the cabling.

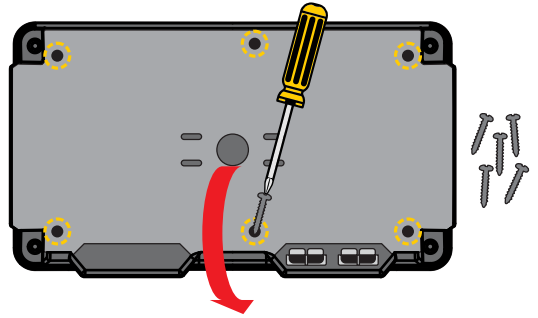

2. There is a pre-drilled hole for cabling on the face of the battery box, this is covered by the sticker. Locate this hole on the top of the lid that is marked by a large dashed circle. Using a sharp knife, cut the sticker.



3. The DCDC charger must be suitably mounted to the lid of the battery box. There are 4 threaded holes on the top of the lid, these are located under the smaller dashed circles. If you wish to make use of these holes to mount your DCDC charger, again cut the sticker with a sharp knife. If you need to drill holes into the battery box lid, caution must be taken to ensure cables beneath are not damaged.

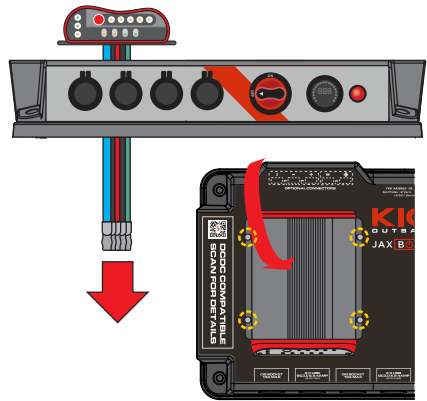

4. Crimp Anderson connectors onto the solar and alternator input wires including the ignition trace wire.

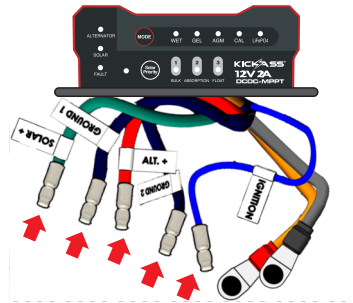

5. Connect the outlet wires of your DCDC Charger to the red and black terminal posts.

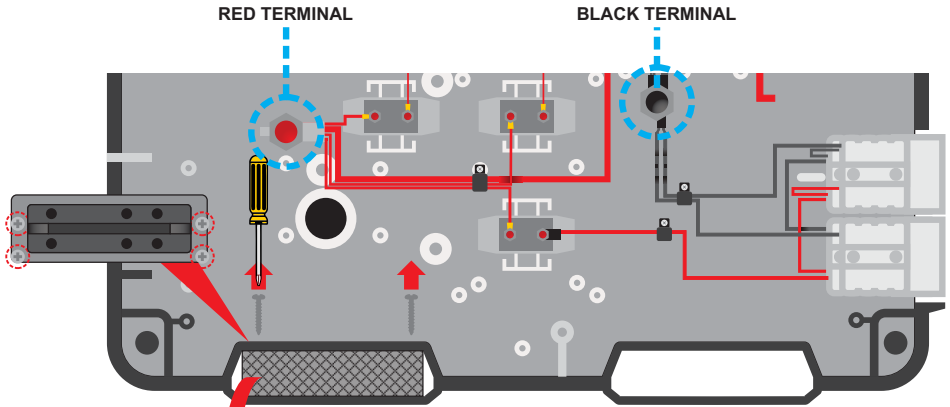

6. Remove the 4 screws holding the piece of plastic in and push the foam block out.

7. Using appropriate screws, attach the two and three pin Anderson style plugs to the piece of plastic. Connect the wires to the appropriate port in the Anderson style plug.

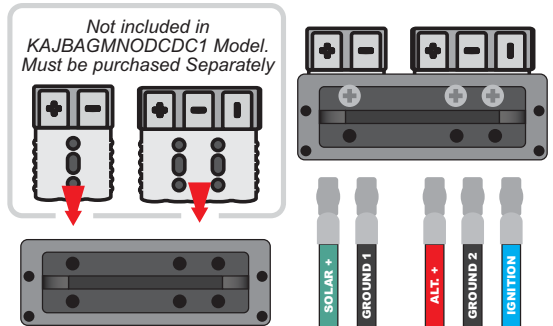

8. Slide the mounted anderson style connectors into the slot in the battery box and return the 4 screws to hold the mount in.

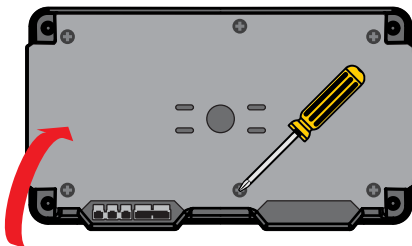
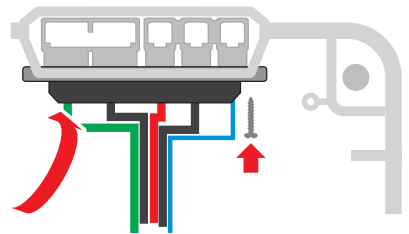

9. Replace the cover concealing the cabling and carefully return the 6 screws.

CONNECTING TO ALTERNATOR INPUT

CONNECTING TO UNREGULATED SOLAR

KickAss Battery Box includes a built-in DC-DC Charger with a MPPT regulator suitable for charging from unregulated solar panels. To connect your solar panel to the regulator simply plug it in via the anderson style plug on your battery box.

Note:

- Your solar panel open circuit voltage must not exceed 32 VoC, the voltage of your panel can generally be found on the sticker on the rear of your solar panel
- If your solar panel is fitted with a built-in regulator, you will need to bypass the regulator port. Alternatively you can connect your regulated solar panel to any of the 6 in/out anderson style connectors.

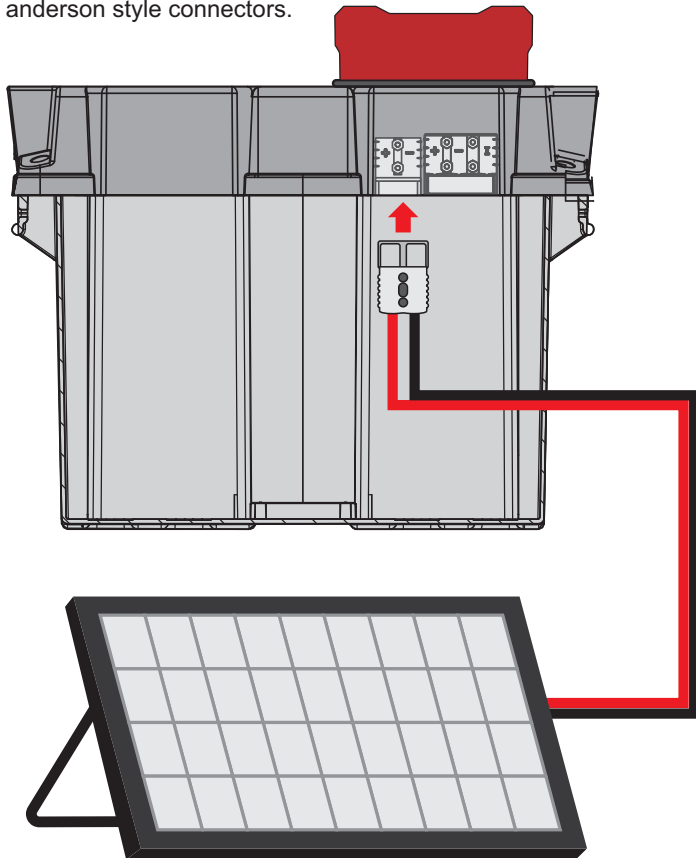

UNREGULATED SOLAR PANEL 32V MAX

TECHNICAL SPECIFICATIONS

BATTERY BOX INFORMATION

Material	ABS
Temperature Range	-10°C - +60°C

BATTERY INFORMATION

Supported Chemistries	AGM, Calcium, Wet, Gel or Lithium (Deep Cycle Only)
MAX Battery Dimensions	340mm L x 185mm W x 235mm H (with Silicone Mat)
MAX Battery Weight	35kg

PORTS (INPUT/OUTPUT)

4 x (50A) Anderson Style Plugs	Input / Output Capable Maximum Combined 50A Current Rating WARNING: 1. Do not plug in multiple chargers as inputs 2. Do not use an external charger while the DC DC Charger is operating 3. Exceeding 50A combined current rating will trigger the safety breaker
3 x Cigarette Socket Outputs	Maximum 10A output per socket
1 x Dual USB / QC 3.0 Outputs	2.4A Standard USB Output QC 3.0 Output (5V/3.1A, 9V/2A, 12V1.5A)

DCDC CHARGER MODEL

ALTERNATOR INPUT

1 x Triple Anderson Style Plug	9-32V DC Starter Battery Input (+/-) Ignition Override Input (I)
--------------------------------	---

SOLAR INPUT

1 x (50A) Anderson Style Plug	Minimum Solar Input Voltage: 9V DC Maximum Solar Input Voltage: 32V DC
-------------------------------	---

FREQUENTLY ASKED QUESTIONS

Q. If storing my KickAss Power Station for long periods, what should I do to look after my battery's health?

An AGM battery is best stored fully charged. The KickAss Power Station is fitted with a Master Switch that allows all outlets to be disconnected from the battery for storage - meaning nothing can drain the battery over time.

For short term storage we recommend fully charging the battery with a 240V mains charger, before switching off the Master Switch and storing.

For longer term storage, we recommend instead to connect a 240V mains charger to the battery in order to continually maintain a full state of charge - this process is called trickle charging.

Q. Is the Power Station waterproof?

The KickAss Power Station has been designed to be as resistant to moisture and dust as possible, though it is not waterproof.

Do not leave exposed to rain or weather, and do not submerge.

For more information visit us at supportportal.kickassproducts.com.au

THANK YOU FOR CHOOSING
KICKASS[®]
JAXBOX X3
POWERSTATION



YOUR COMPLETE
12-VOLT POWER
SOLUTION