

↗ DOMETIC

TENTS & EQUIPMENT SANTORINI, REUNION, PICO



Santorini FTK4X8/2X4, Reunion FTG5X5/4X4, Pico FTC2X2/1X1

EN

Tent

Installation and Operating Manual10

© 2022 Dometic Group. The visual appearance of the contents of this manual is protected by copyright and design law. The underlying technical design and the products contained herein may be protected by design, patent or be patent pending. The trademarks mentioned in this manual belong to Dometic Sweden AB. All rights are reserved.



Santorini FTK 4X8

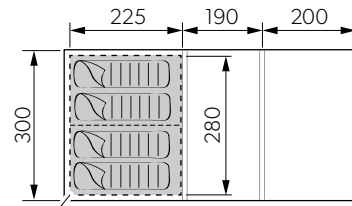
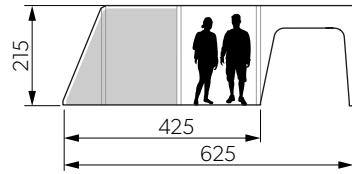

80 x 46 x 44 cm
31.75 kg
SKU 9120002093

Santorini FTK 2X4

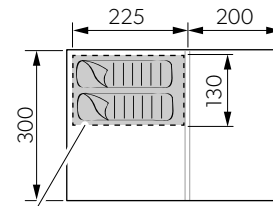
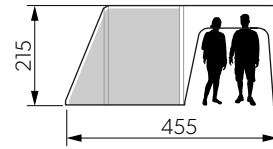

75 x 43 x 40 cm
24.9 kg
SKU 9120002099

Reunion FTG 5X5

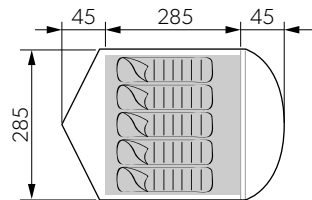
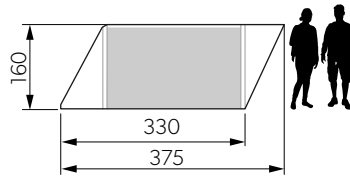

70 x 30 x 30 cm
14.22 kg

Reunion FTG 4X4

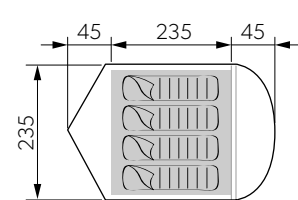
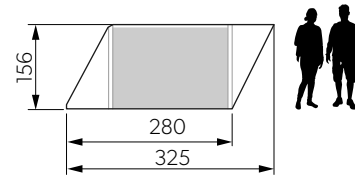

60 x 30 x 30 cm
12.52 kg

Pico FTC 2X2

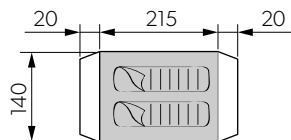
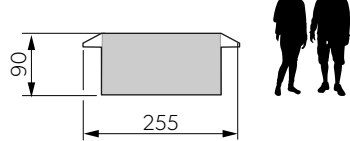

68 x 29 x 29 cm
10.98 kg

Pico FTC 1X1

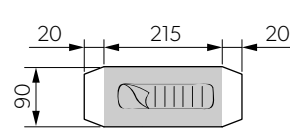
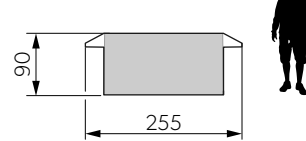

65 x 28 x 28 cm
9.34 kg

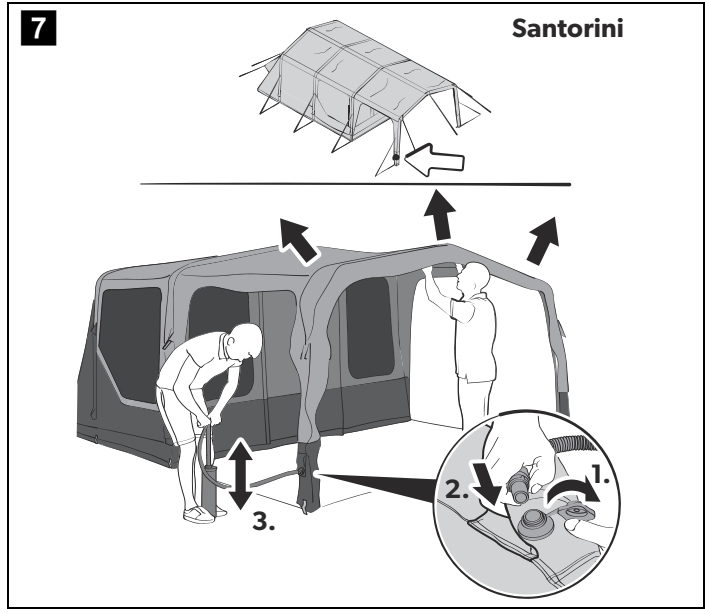
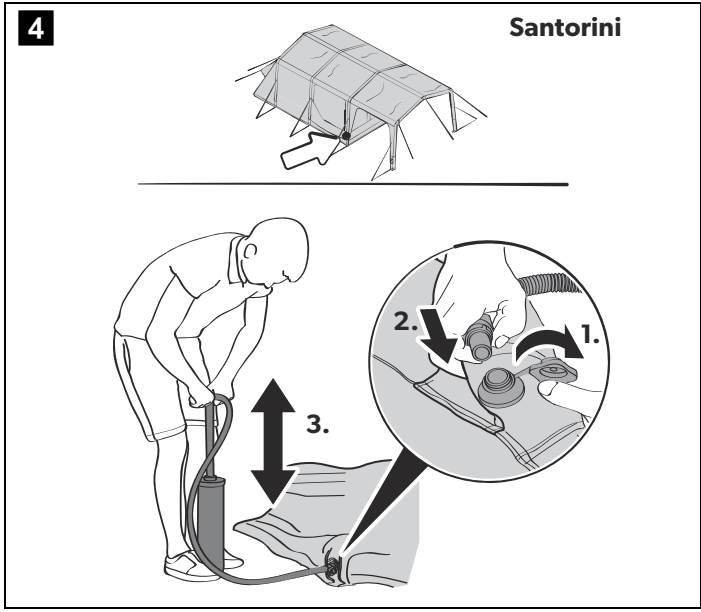
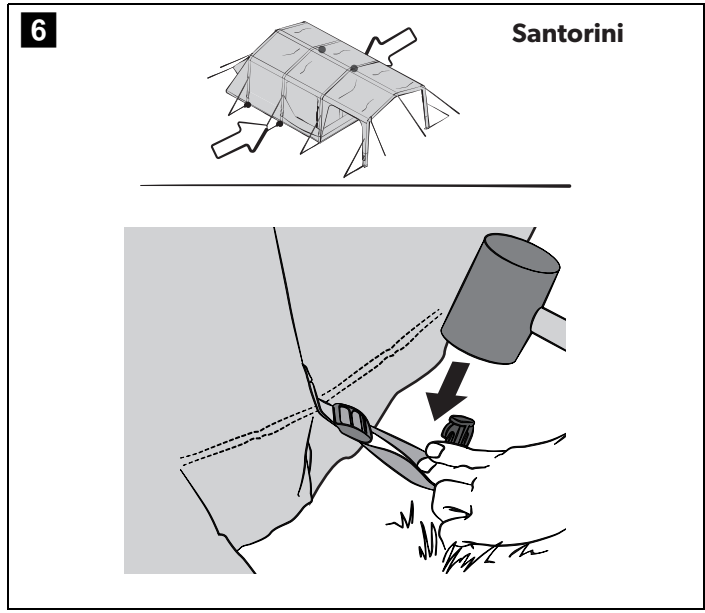
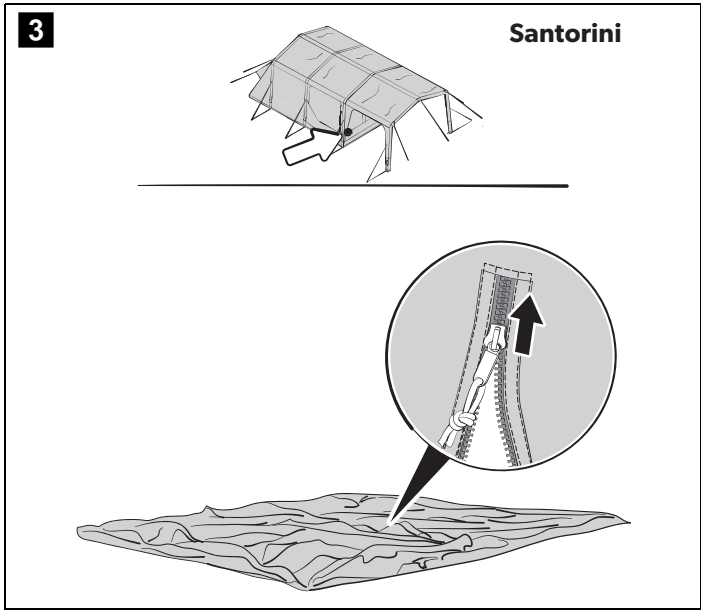
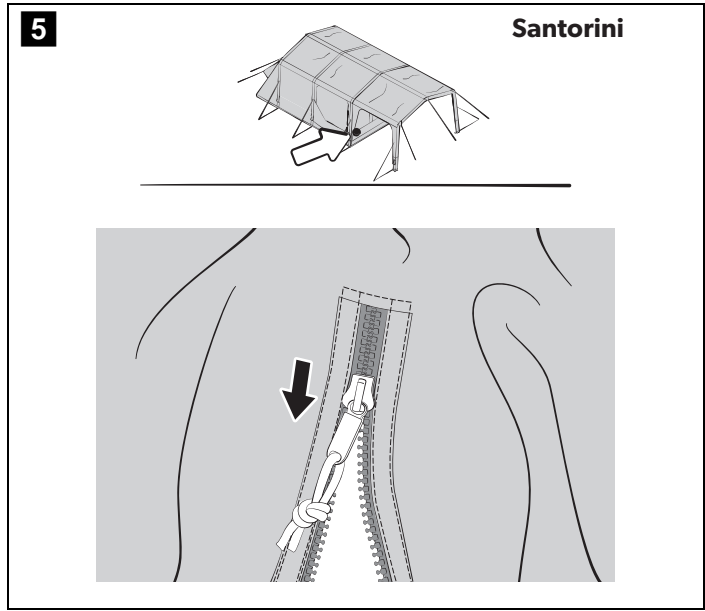
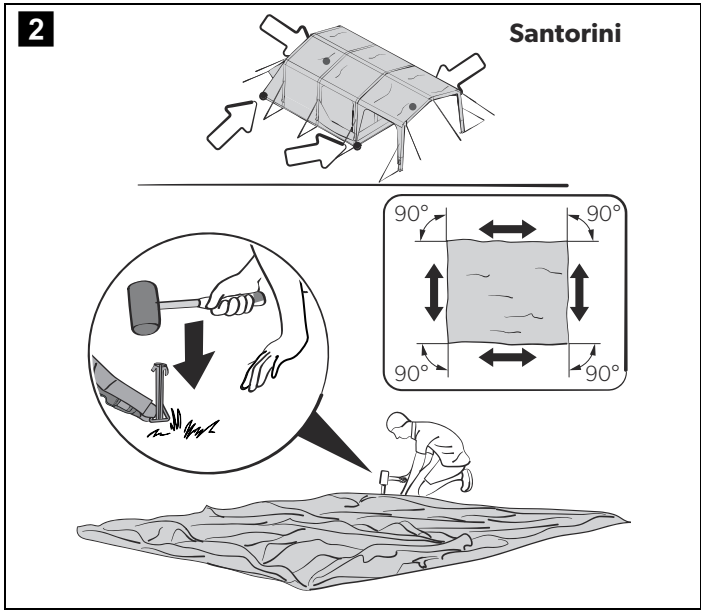

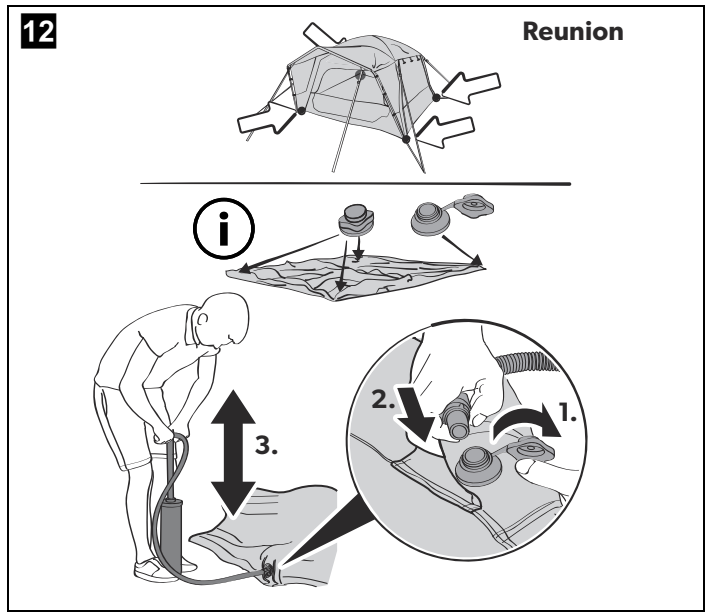
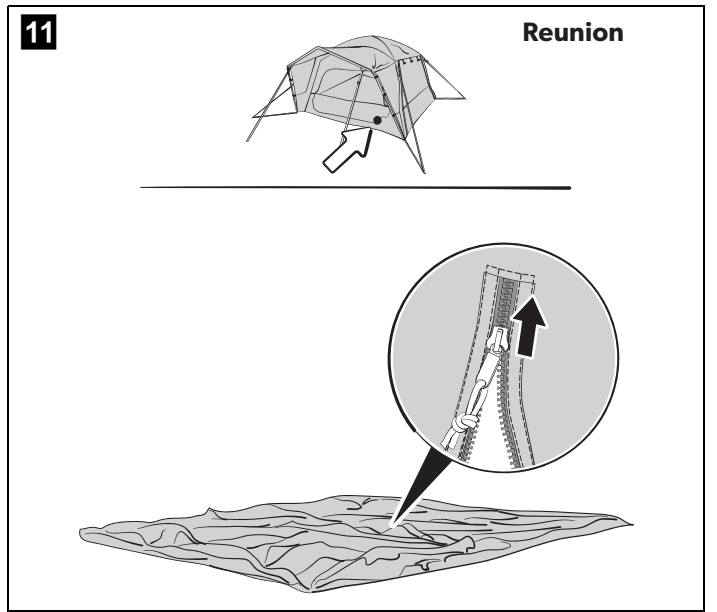
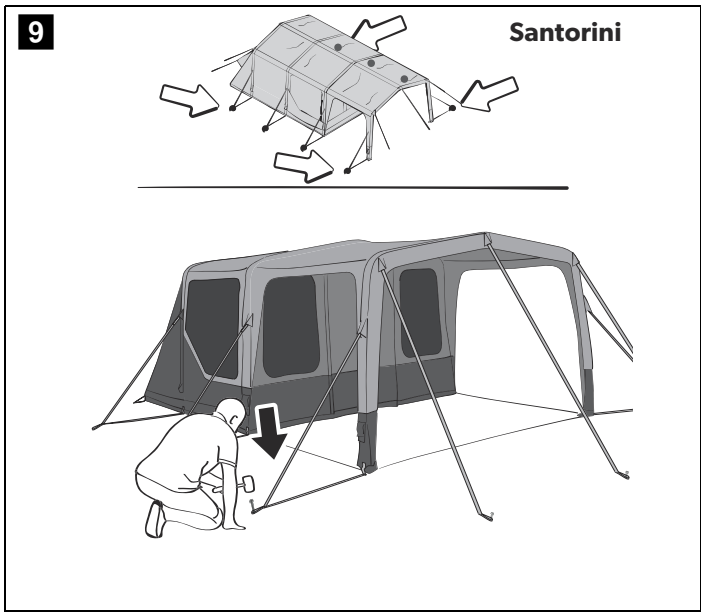
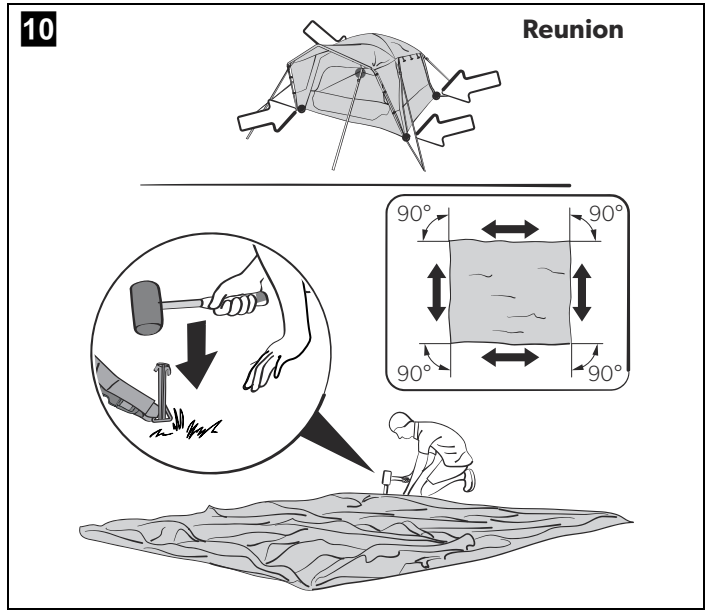
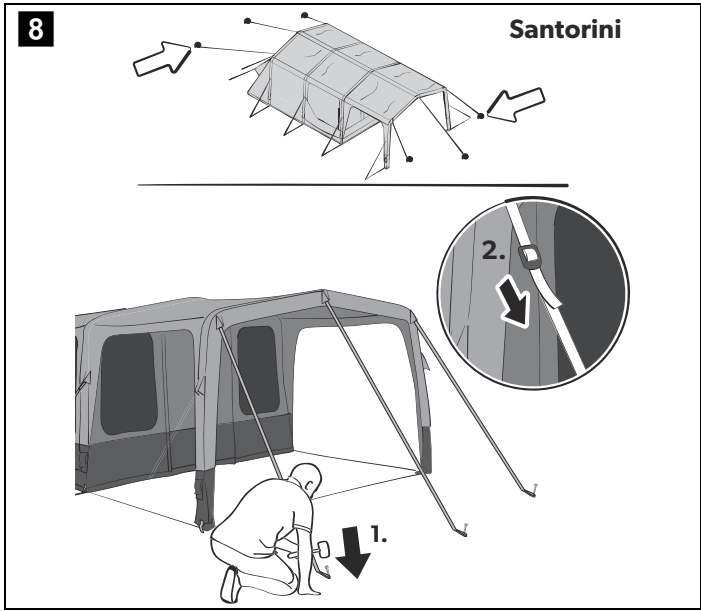

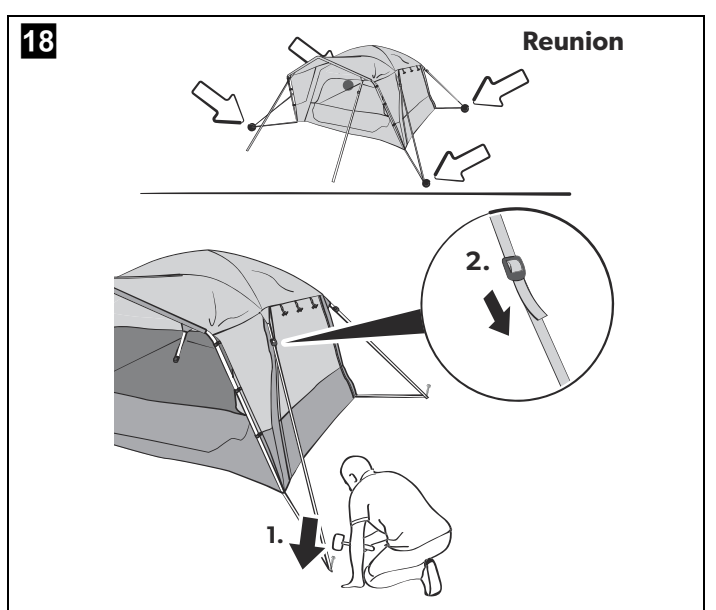
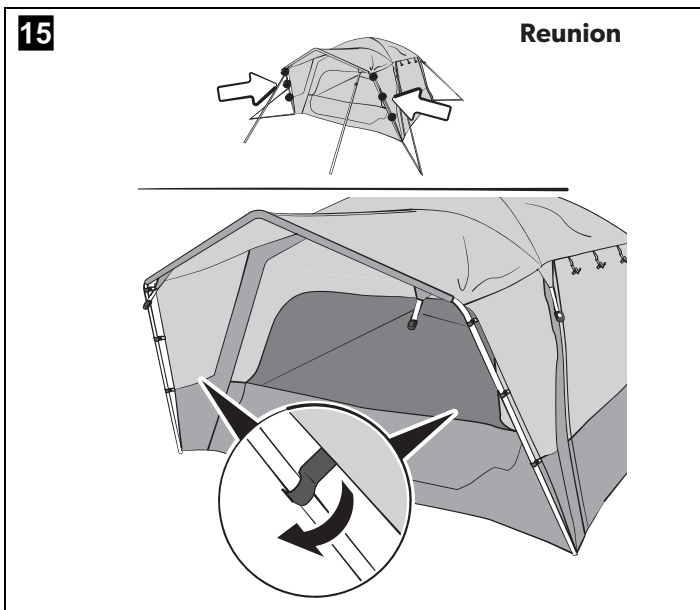
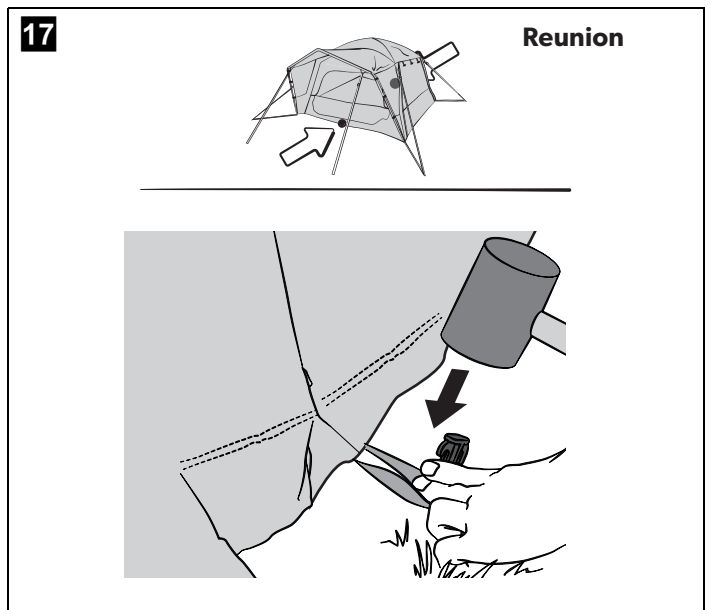
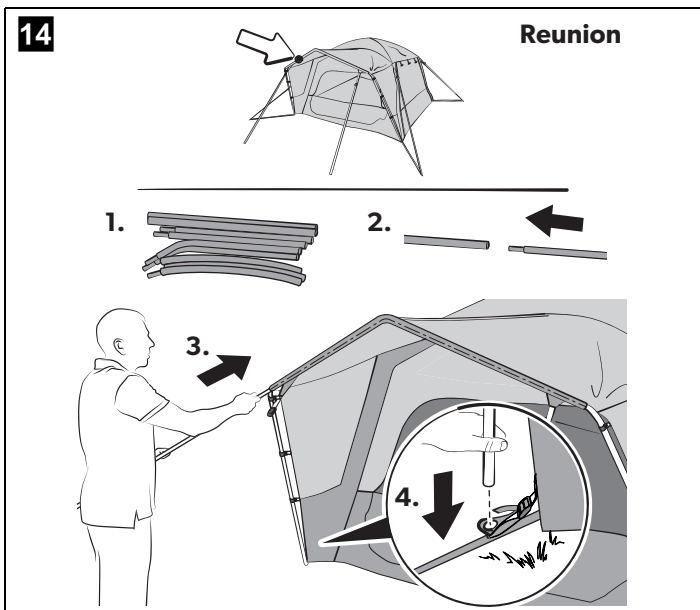
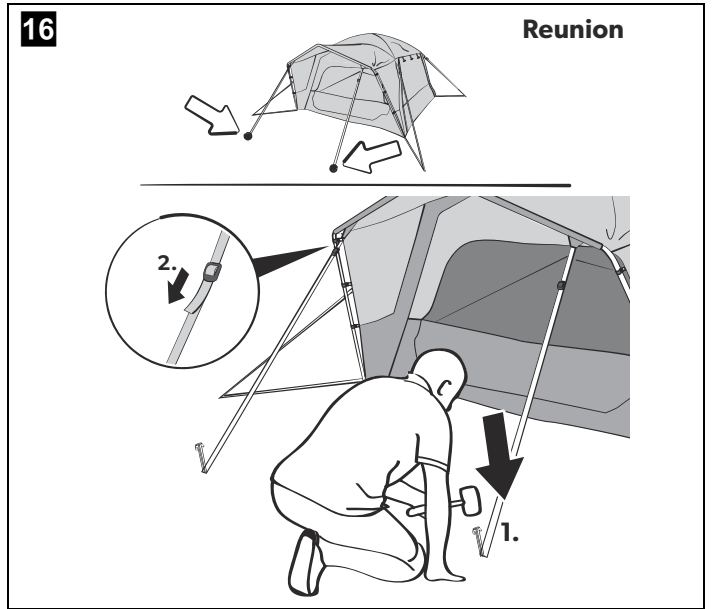
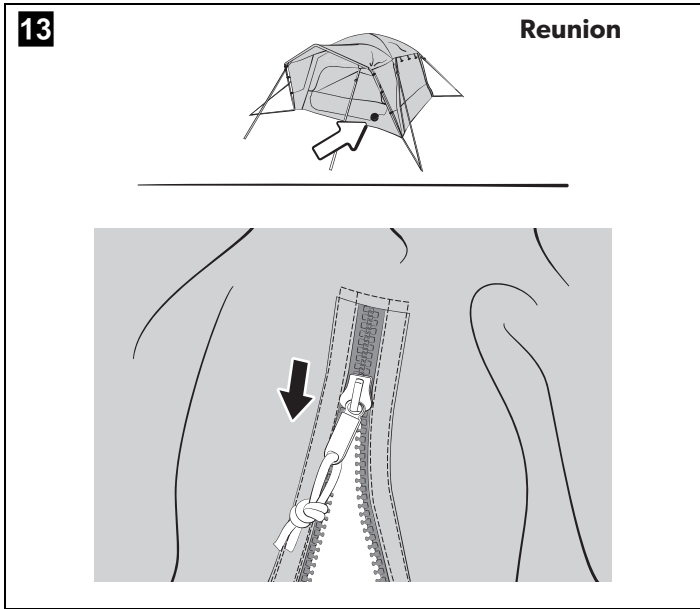

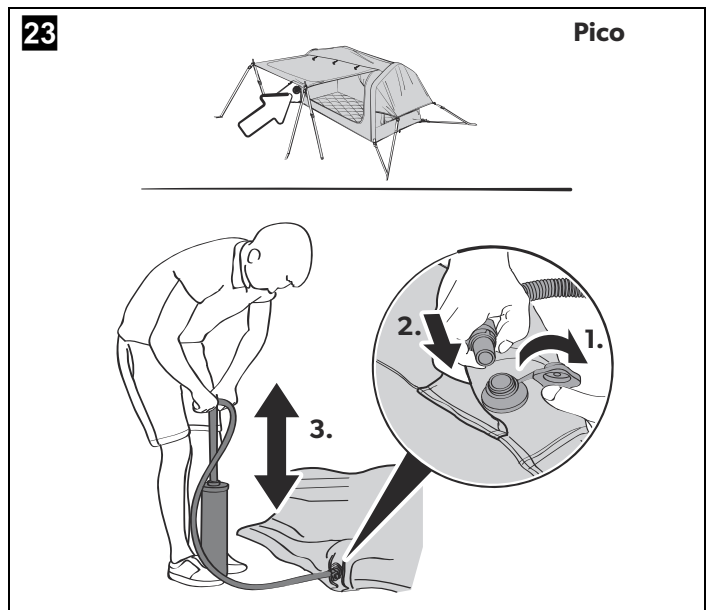
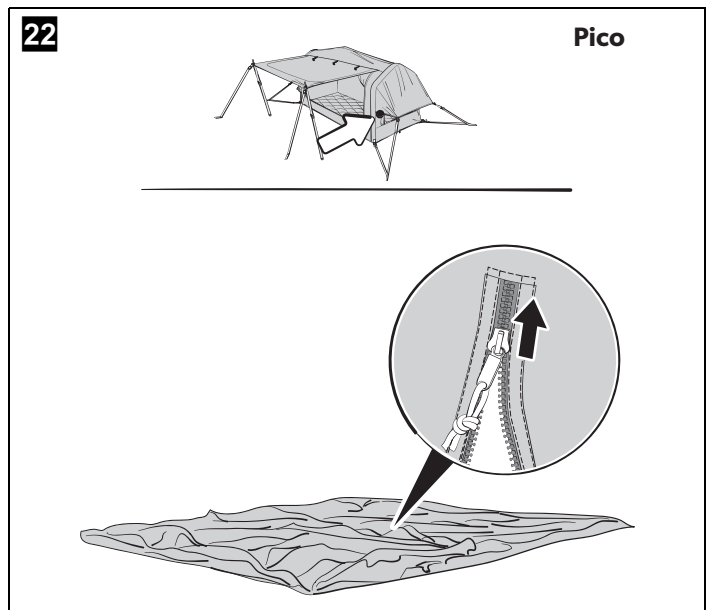
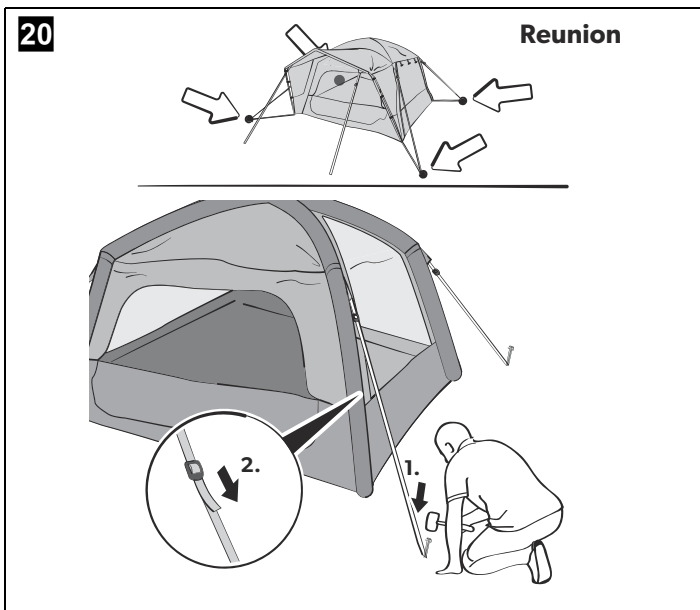
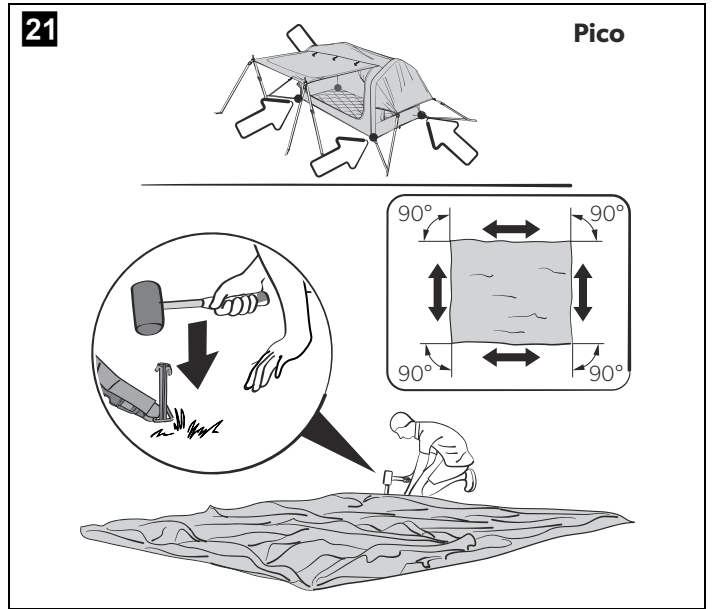
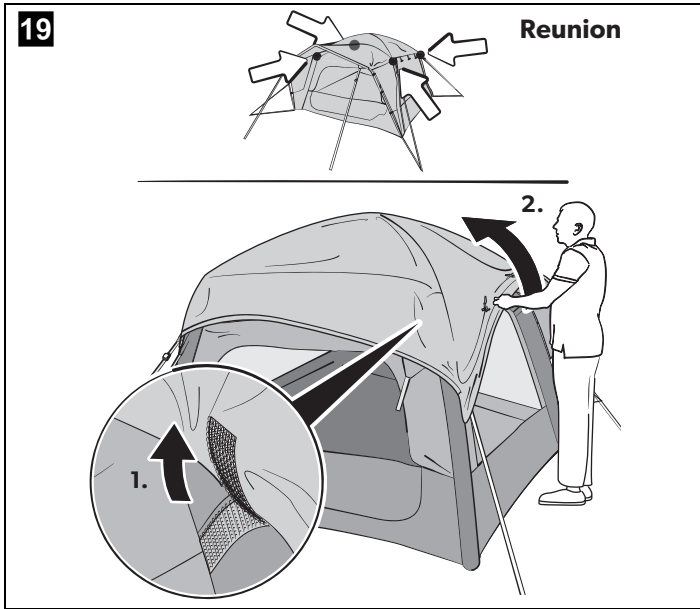

24

Pico

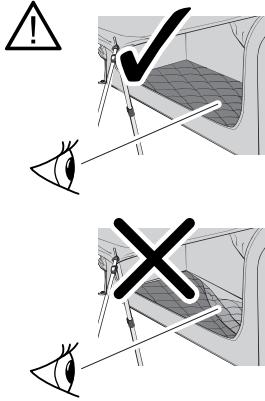

27

Pico

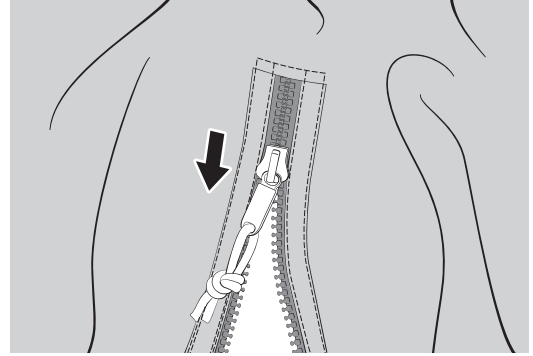

25

Pico FTC 1X1

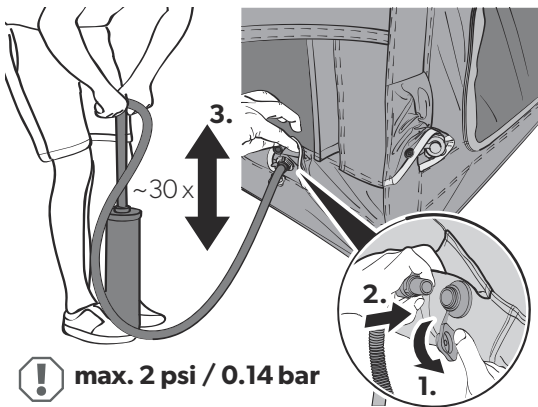

! max. 2 psi / 0.14 bar

28

Pico

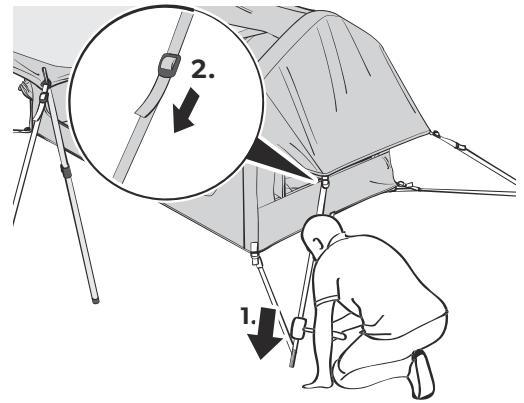

26

Pico FTC 2X2

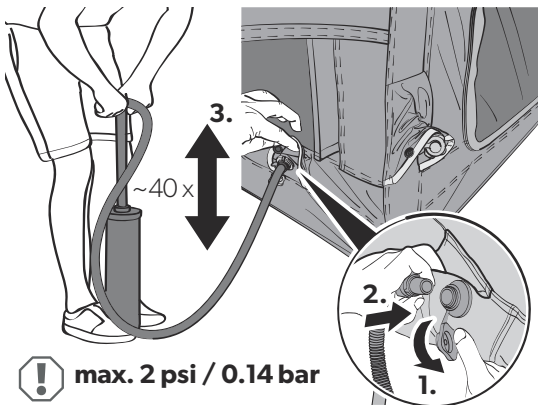

! max. 2 psi / 0.14 bar

29

Pico

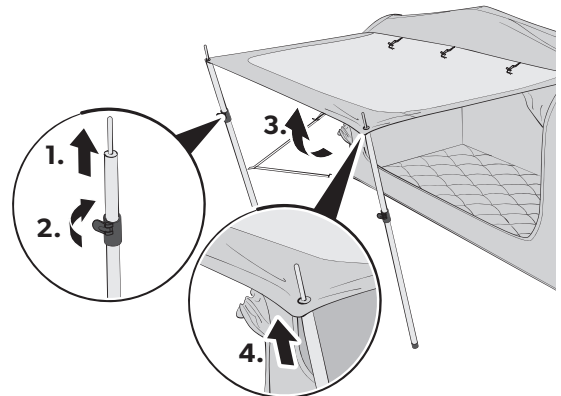

30

Pico

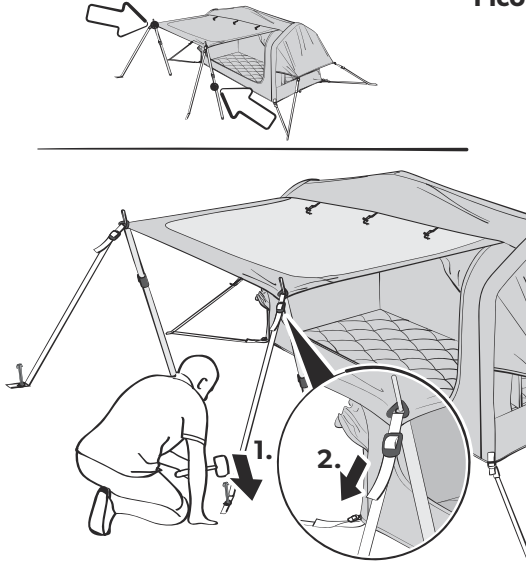

31

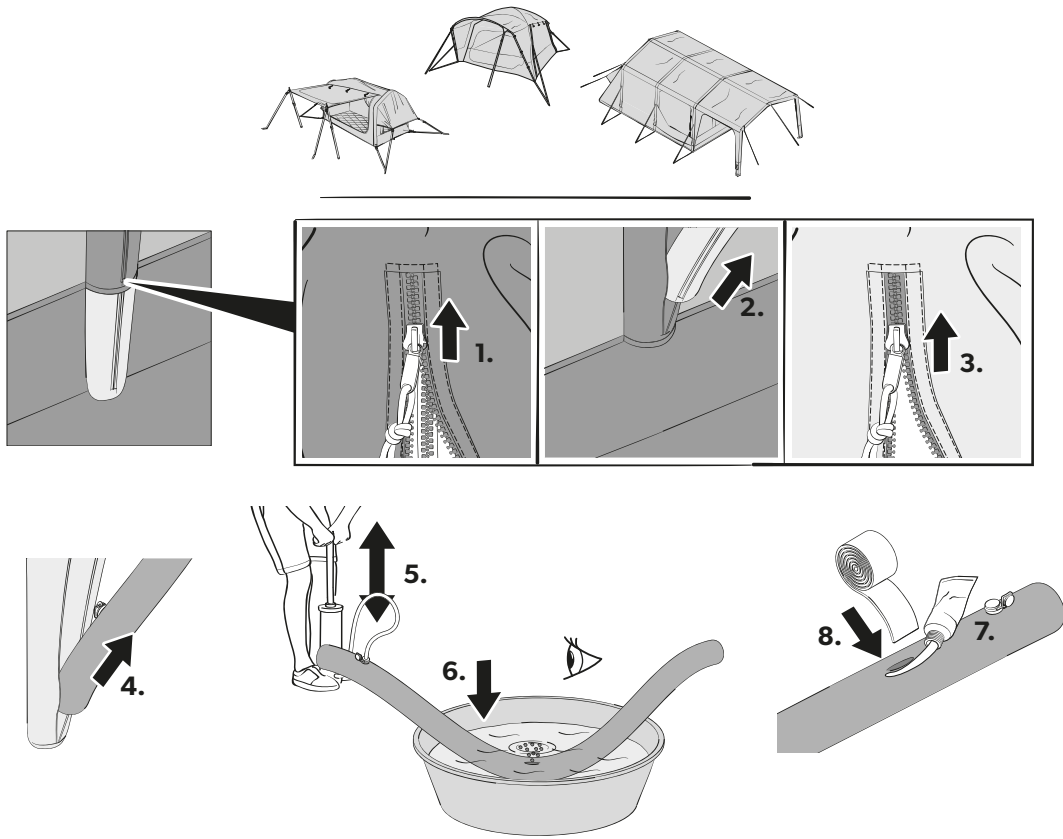

Please read these instructions carefully and follow all instructions, guidelines, and warnings included in this product manual in order to ensure that you install, use, and maintain the product properly at all times. These instructions MUST stay with this product.

By using the product, you hereby confirm that you have read all instructions, guidelines, and warnings carefully and that you understand and agree to abide by the terms and conditions as set forth herein. You agree to use this product only for the intended purpose and application and in accordance with the instructions, guidelines, and warnings as set forth in this product manual as well as in accordance with all applicable laws and regulations. A failure to read and follow the instructions and warnings set forth herein may result in an injury to yourself and others, damage to your product or damage to other property in the vicinity. This product manual, including the instructions, guidelines, and warnings, and related documentation, may be subject to changes and updates. For up-to-date product information, please visit documents.dometic.com, dometic.com.

Explanation of symbols



DANGER!

Safety instruction: Indicates a hazardous situation that, if not avoided, will result in death or serious injury.



WARNING!

Safety instruction: Indicates a hazardous situation that, if not avoided, could result in death or serious injury.



CAUTION!

Safety instruction: Indicates a hazardous situation that, if not avoided, could result in minor or moderate injury.



NOTICE!

Indicates a situation that, if not avoided, can result in property damage.



NOTE

Supplementary information for operating the product.

General safety instructions



DANGER! Failure to obey this instruction will cause death or serious injury.

Hazard of carbon monoxide poisoning

- Never use a fuel-burning appliance such as barbecues or gas heaters inside the tent. The burning process produces carbon monoxide which accumulates inside the tent as there is no flue.



WARNING! Failure to obey these warnings could result in death or serious injury.

Fire hazard

- Ensure you know the fire precaution arrangements on the site.
- Do not cook inside the tent or use open flames.
- Leave the tent immediately in case of fire.

Beware of suffocation

- Ensure ventilation openings are open and clear all the time to avoid suffocation.



CAUTION! Failure to obey these cautions could result in minor or moderate injury.

Risk of injury

- This device is not intended for use by persons (including children) with reduced physical, sensory or mental capabilities, or lack of experience and knowledge, unless they have been given supervision or instruction concerning use of the device by a person responsible for their safety.
- Do not allow children to play around the tent and ensure that suitable protective footwear is worn. Guy lines are a trip hazard and pegs can be sharp.
- Cleaning and user maintenance may not be carried out by unsupervised children.
- Keep passage ways clear.

Scope of delivery

Santorini FTK 4X8/2X4

Component	Quantity
Tent	1
Hand pump	1
Peg bag	1
Carry bag	1
Repair kit	1
Installation and operating manual	1

Reunion FTG 5X5/4X4

Component	Quantity
Tent	1
Aluminium canopy pole	1
Hand pump	1
Peg bag	1
Carry bag	1
Repair kit	1
Installation and operating manual	1

Pico FTC 2X2/1X1

Component	Quantity
Tent	1
Adjustable poles	2
Hand pump	1
Peg bag	1
Carry bag	1
Repair kit	1
Installation and operating manual	1

Accessories

Santorini FTK 4X8/2X4

Description	Ref. no.
4X8 inner tent	9120002093
4X8 carpet	9120002094
4X8 footprint	9120002095
2X4 inner tent	9120002099
2X4 carpet	9120002100
2X4 footprint	9120002101

Reunion FTG 5X5/4X4

Description	Ref. no.
5X5 carpet	9120002105
5X5 footprint	9120002106
4X4 carpet	9120002110
4X4 footprint	9120002111

Pico FTC 2X2/1X1

Description	Ref. no.
2X2 footprint	9120002114
1X1 footprint	9120002117

Intended use

This tent is suitable for:

- Light to moderate weather
- Touring

This tent is **not** suitable for:

- Very strong winds or snowfall
- Seasonal pitch or commercial use

This product is only suitable for the intended purpose and application in accordance with these instructions.

This manual provides information that is necessary for proper installation and/or operation of the product. Poor installation and/or improper operating or maintenance will result in unsatisfactory performance and a possible failure.

The manufacturer accepts no liability for any injury or damage to the product resulting from:

- Incorrect assembly or connection, including excess voltage
- Incorrect maintenance or use of spare parts other than original spare parts provided by the manufacturer
- Alterations to the product without express permission from the manufacturer
- Use for purposes other than those described in this manual

Dometic reserves the right to change product appearance and product specifications.

Using the tent



CAUTION! Risk of injury and material damage

Never open the zipper on the protective sleeve while an air pole is inflated. This will result in the air pole bursting.

Before first use

Familiarize yourself with the product by carrying out a test set up before the product is used for the first time. Check if the scope of delivery is complete.

Santorini, Pico only: Weathering your product before first use

The product is manufactured with materials that require preparation before use to maximize its weatherproofing.

1. Fully set up the product outside when rain is expected or where you can hose the outside of the product to become thoroughly wet.

This process is known as weathering. The weathering process tightens the fabric, and allows the cotton in the sewing thread to swell and fill the holes made by the sewing needle during the manufacturing process.

2. Allow the product to dry thoroughly before packing away.

By following this process before first use, will ensure that the product weatherproofing will improve with subsequent soakings.

Choosing a site

Choose a flat site that is protected from wind:

1. If necessary, use a windbreak.
2. Choose a shaded site to avoid UV degradation of the fabric.
3. Avoid pitching under trees as falling branches, resin, etc. can damage the product.
4. Clear the site of sharp stones and debris to avoid damaging the groundsheet.
5. Set up the product with the doors facing away from the wind.

Setting up the tent



CAUTION! Risk of injury and material damage

- Do not use any type of compressor designed to inflate car tires.
- Only inflate the mattress (if available) to a maximum of 2 psi/0.14 bar.
- Only inflate the air poles into the green zone of the pressure gauge of the supplied hand pump (10 psi/0.69 bar).



NOTICE! Material damage

Do not open or close the zippers by force.



NOTE

- The tent comes with general purpose pegs. These will be suitable for many sites but for some types of ground special pegs will be needed. Ask your dealer.
- Drive the pegs at a 45° angle away from the tent into the ground.
- Peg the guy lines in line with the seam it starts from.

Keep the following tips in mind while setting up the tent:

- The figures provide a general overview of the set-up. The actual set-up will vary slightly based on the model of tent.
- Get help. The set-up is easier with more people.
- Inflate the air poles from front to rear.
- After standing the tent upright, check the corner pegs and re-peg if necessary. The groundsheet on the inside should be taut and in a rectangular shape.
- Peg the guy lines so that the tent is under tension without distorting the shape.
- If available, attach the storm straps.
- Check the guy lines from time to time to ensure adequate tension, if necessary use the runners to adjust.

Set up the tent as follows:

1. To protect the tent from dirt and damage, lay down a groundsheet or footprint before unpacking.
2. Unpack the tent.
3. Separate and identify the different components.
4. Proceed as shown to set up the tent:
 - Santorini: fig. **2**, page 4 to fig. **9**, page 5.
 - Reunion: fig. **10**, page 5 to fig. **20**, page 7.
 - Pico: fig. **21**, page 7 to fig. **30**, page 9.

Removing the flysheet (Reunion only)

- ▶ Proceed as shown to remove the flysheet: fig. **19**, page 7.
- ▶ Attach the flysheet before dismantling the tent.

Dismantling the tent



NOTICE! Material damage

Do not use force when dismantling the tent. Otherwise you might damage any material.

1. Remove any dirt on the outside.
2. Close all window blinds or remove curtains.
3. Close all doors and openings.
4. If installed, push the canopy pole out of the sleeve, do not pull.
5. Remove all lines and straps.
6. Remove all pegs between the corner pegs.
7. Open the valves on each pole.
8. Wait until most of the air has been expelled.
9. Remove the four corner pegs.
10. Fold/roll the tent towards the valves to expel more air.
11. When deflated, roll the tent to fit into the carry bag.
12. Ensure that all parts are clean before packing them into the carry bag.
13. If the tent is wet or damp when packing away, dry fully as soon as possible. Otherwise the fabric may start to show signs of mold.

Cleaning and maintenance



NOTICE! Damage hazard

- Do not use sharp or hard objects or cleaning agents for cleaning.
- Do not use alcohol based materials, chemicals, soap and detergents for cleaning.
- Remove bird droppings and tree resin as soon as possible to avoid permanent damage to the material.

1. If necessary, clean the product with clean water and a soft brush.
2. Apply impregnation against water and UV radiation before each trip.

Storing the tent



NOTE

- Fully set up the tent for cleaning.
- Choose a sunny day for cleaning to ensure the material will dry thoroughly.

1. Clean the tent.
2. Air fully and ensure the tent is totally dry before packing away.
3. Store in a well ventilated dry place.

Troubleshooting



NOTE

- During first exposure to water there may be some moisture at the seams. Through this moisture the threads will swell and fill the holes that are created in the sewing process.
- A fully equipped spare parts kit should include:
 - Waterproofer
 - Repair tape and repair solution
 - Silicone spray for the zippers
 - Spare pegs

Problem	Solution
Tent only inflates with difficulties	<ul style="list-style-type: none">▶ Check that the valve is fully screwed into the air pole.▶ Check if the inflation tube is twisted at the valve. This may be indicated by noise. Untwist the inflation tube
Air leak	<ul style="list-style-type: none">▶ Check that the valve is fully screwed into the air pole and the ring seal is in place.▶ Check that the cap of the valve is done up tightly.▶ Check for punctures, see chapter "Repairing a puncture in the air pole" on page 12.
Water leak	<ul style="list-style-type: none">▶ Check for leaky seams, damaged tapings and moist areas.▶ If you cannot find any leaks, see chapter "Condensation" on page 12.▶ If you find any leaks, apply seam sealant.
Rip in the fabric	<ul style="list-style-type: none">▶ Use repair tape to seal the fabric.▶ Have repairs carried out by an authorized specialist.

Condensation

All tents suffer from internal condensation if one or more of the following conditions apply:

- high air humidity
- high ground moisture
- a drop in temperature

Severe condensation can run down the inside of the roof and drip off ties, tapes and other internal fittings and can be mistaken for leaking.

- ▶ Increase ventilation by opening doors and/or windows.
- ▶ Install a waterproof groundsheet.

Repairing a puncture in the air pole

If the air pole loses air, proceed as follows:

1. Unzip the outer sleeve holding the air pole.
2. If installed, close isolation valves.
3. Remove the air pole.
4. Deflate the air pole.
5. Unzip the protective sleeve to expose the inflatable tube.
6. Blow some air into the inflatable tube.
7. Submerge the tube in water.
8. Locate the puncture.
9. Use repair tape and repair solution to seal the hole.
10. Zip the inflatable tube back into the protective sleeve.
11. Zip the air pole back into the outer sleeve.

Replacing the aluminum pole (if available)

- ▶ Replace damaged aluminum poles immediately, if any. Please contact your retailer or the manufacturer's branch in your country (see dometic.com/dealer).

Disposal



- ▶ Place the packaging material in the appropriate recycling waste bins wherever possible.
- ▶ Consult a local recycling center or specialist dealer for details about how to dispose of the product in accordance with the applicable disposal regulations.

Warranty

If the product does not work as it should, please contact your retailer or the manufacturer's branch in your country (see dometic.com/dealer). The warranty applicable to your product is 3 year(s).

For repair and warranty processing, please include the following documents when you send in the device:

- A copy of the receipt with purchasing date
- A reason for the claim or description of the fault

Australia only

Our goods come with guarantees that cannot be excluded under the Australian Consumer Law. You are entitled to a replacement or refund for a major failure and for compensation for any other reasonably foreseeable loss or damage. You are also entitled to have the goods repaired or replaced if the goods fail to be of acceptable quality and the failure does not amount to a major failure.

New Zealand only

This warranty policy is subject to the conditions and guarantees which are mandatory as implied by the Consumer Guarantees Act 1993(NZ).

Local support

Please find local support at the following link address:
dometic.com/dealer

Warranty conditions

The warranty covers manufacturing defects, materials and parts. The warranty does not cover fading of the cover and wear and tear due to UV radiation, misuse, accidental damage, storm damage, or permanent, semi-permanent or commercial use. It does not cover any resulting damage. Please contact your dealer for claims. This does not affect your statutory rights.

In addition, the warranty also does not cover the following cases:

- Any damage from improper preparation before first use, such as weathering your product.
- Accidental or malicious damage by negligence or faults caused by a failure to provide routine maintenance.
- Accessories such as pegs and guy lines.
- Repairs carried out by repair agents that are not authorized by Dometic.
- Any loss or damage caused by a failure to follow the manufacturer's instructions for usage, installation, operation or maintenance.
- Damage/failure to operate caused as a result of improper installation or infestations of vermin, pests or insects.
- Perceived faults where the product is operating within the normal range of Dometic performance specifications and these performance specifications were made known to you prior to purchase.

dometic.com

**YOUR LOCAL
DEALER**

dometic.com/dealer

**YOUR LOCAL
SUPPORT**

dometic.com/contact

**YOUR LOCAL
SALES OFFICE**

dometic.com/sales-offices
